



LPS-150 SCALE

Operation Manual

Contents subject to change without notice

**Version 1.0
2006-08-10**

Declarations of compliance

United States

This equipment has been tested and found to comply with the limits for a Class A digital device, pursuant to Part 15 of the FCC Rules. These limits are designed to provide reasonable protection against harmful interference when the equipment is operated in a commercial environment. This equipment generates, uses, and can radiate radio frequency energy and, if not installed and used in accordance with the instruction manual, may cause harmful interference to radio communications. Operation of this equipment in a residential area is likely to cause harmful interference in which case the user will be required to correct the interference at his own expense.

Canada

This digital apparatus does not exceed the Class A limits for radio noise emissions from digital apparatus set out in the Radio Interference Regulations of the Canadian Department of Communications.

Le présent appareil numérique n'émet pas de bruits radioélectriques dépassant les limites applicables aux appareils numériques de la Classe A prescrites dans le Règlement sur le brouillage radioélectrique édicté par le ministère des Communications du Canada.

Warnings Electrical installation

For your protection, all mains (11 0V or 230V) equipment used where damp or wet conditions may occur, must be supplied from a correctly fused source and protected by an approved ground fault protection device (RCD, GFCI etc.).

IF IN DOUBT SEEK ADVICE FROM A QUALIFIED ELECTRICIAN.

To avoid the possibility of electric shock or damage to the machine, always isolate from the mains power supply before carrying out any routine maintenance.

Cleaning the scale

Harsh abrasives, solvents, scouring cleaners and alkaline cleaning solutions, should not be used especially on the display windows. Under no circumstances should you attempt to wipe the inside of the machine.

The outside of the machine may be wiped down with a clean cloth moistened with water containing a small amount of liquid soap.

EMC compliance

The following warning may be applicable to your machine.

WARNING: This is a class A product. In a domestic environment this product may cause radio interference in which case the user may be required to take adequate measures.

Operation Manual

Thank you for purchasing the 140 indicator. Please read all operating instructions carefully before use and keep the following points in mind:

* Avoid lengthy exposure to extreme heat or cold, your scale works best when operated at normal room temperature. Always allow the scale to acclimate to a normal room temperature before use

* Allow sufficient warm up time. Turn the scale on and wait for a few minutes if possible, to give the internal components a chance to stabilize before weighing.

* These electronic scales are precision instruments. Do not operate near an in-use cell phone, radio, computer or other electronic device. These devices emit RF and can cause unstable scale readings. If your scale ever performs poorly, try moving the scale to a different room or location.

* Avoid using in condition of heavy vibration and airflow.

* Read the weight reading in short time after loading. The output signature of load cell and A/D may be little influenced after weighing for a long time.

CONTENT

I . SPECIFICATIONS.	P1
II . KEY FUNCTION.	P3
III. CALIBRATION.	P6
IV. Examination mode.....	P9
V . SETUP MODE.	P11
VI. Details of RS232 Communication.....	P18
VII. Calibration resolution, division and capacity	P21
VIII. Meaning of some displayed symbols.	P24
IX. Direction of indicator with bracket.	P25
X.Key Definition summary:	P26
XI.Parameters setting summary:	P27

I . SPECIFICATIONS:

• *SCALE INDICATOR:*

1. Input signal range: 0mV ~ +30mV
2. Sensitivity: >0.2uV/grad
3. Internal Resolution: Approximately 520,000 counts
4. Display Resolution: can be selected between 500-100,000
5. System Linearity: within 0.01% of FS
6. Loadcell excitation Voltage: +4.4 VDC (MAX current: 55mA)
MAX 4- 350 ohm loadcells. "Only 140 indicator manual"
7. Calibration Method: Software calibration with long-term storage in EEPROM.

• *SERIAL COMMUNICATIONS:*

1. Mode: Full duplex or only output mode can be selected
2. Baud rate: 1200, 2400, 4800, 9600, or 19200 bps
3. Data format: 8N0, 7E1, 7O1
8data bits, non parity, 1 stop bit
7data bits, 1bit even or odd parity, 1 stop bit
4. Protocol: 7selected protocol (include the one compatible with NCI

standard SCP-01)

5. Output data: gross weight, net weight, tare weight, indicator displaying weight, weighing unit etc.

• **OPERATION INTERFACE:**

1. Display: 0.65" (17mm) 7-segment LCD, 5¹/₂ digits
2. Keyboard: 4-key push button

• **POWER:**

1. Alkaline Batteries: 4 x "AAA" size cells

When all displayed segments of LCD flashed, this indicates the batteries are low below 4.9V and you'd better to replace batteries;

When "Lo.bAt" displayed, this indicates the batteries are low below 4.7V and you should replace batteries immediately.

2. AC Adapter: 6VDC, 500mA, with central negative:



3. Work current: ≤25mA

(when voltage in 5Vdc-8Vdc and not include load cell's consumption)

- **OPERATION TEMPERATURE:** 20°C ± 15°C

STORE TEMPERATURE: -10°C-70°C

OPERATION HUMIDITY: ≤95%RH (no condensate)

• **LOADCELL:**

Because of more than one load cell can be used on a scale, following are required on the load cell set to be used with this indicator,

1. Sensitivity: 0.3mV/V --- 3mV/V (must be fit to >0.2uV/display grad)
2. Input Resistor: ≥80 Ω
3. Output Resistor: <10 KΩ

• **LOADCELL WIRING:**

PIN 1: RED, EXCITATION +

PIN2: BLACK, EXCITATION -

PIN3: GREEN, SIGNAL -

PIN4: WHITE, SIGNAL +

"PS/SK/140 MANUAL"

II. KEY FUNCTION:

1. **FACEPLATE:**

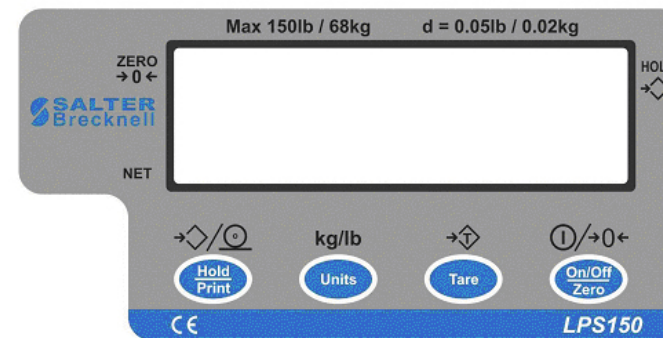

2. **DISPLAY SYMBOL MEANING:**

2.1 Zero ◀-----The scale is at zero point and the gross weight is 0

2.2 Net ◀-----The display reading is net weight, and the tare weight is not 0.

2.3 ▶ Hold -----The scale is under HOLD mode.

It displays the current live weight when ▶ flashed, and the locked reading will be shown when ▶ does not flash and comes steady.

3. **SUMMARY of KEY DEFINITION:**

3.1 In normal weighing mode press and hold down keys for 3 seconds:



(1)



- a. If this key is only set for HOLD (P2=0), press this key to enter or exit HOLD mode.
- b. If this key is only set for PRINT (P2=1), press this key to output the data according to P4 setting.
- c. If this key is set for both HOLD and PRINT function (P2=2), press this key

to output the data according to P4 setting.

(2) 

Choose weighing units among kg-lb-lb: oz

Note: The weighing units that can be used are restricted by display

division, and calibration weight unit (restricted by P8, P9, and P10):

For example, if the calibration unit is “kg”; calibration display resolution is 50kg (that means: P8=5, P9=0, P10=0), and users press UNIT key to choose weighing units. Lb or lb:oz are not allowed to choose, since the display resolution of 100lb or 2000oz is not available to this indicator.



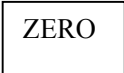

(3) 

Tare the weight. This function can be activated only when the scale is in stable mode and the gross weight is not negative value.

(4) 

Zero function. When the weight is within zero range, it will active as ZERO function and clear the tare weight. When the weight is not within zero setting range (P13 set), the scale will show 0`-`-`-` (zero point is over the setting range), or 0_`-`-`-` (zero is below the setting range).



3.2. In normal weighing mode and hold down time longer than 3s:

(1)  (2)  (3) 

Same meaning with that in 3.1

(4)  : Power off the scale.

(5)  + 

Hold these two buttons to show firmware version; A/D code or input working voltage of indicator.

(6)  + 

Hold these two buttons to enter setting mode when the sealed calibration switch is on.

(7)  + 

Hold these two buttons to enter calibration mode when the sealed calibration switch is on.

3.3 In setting mode:

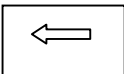
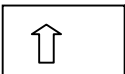
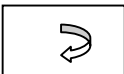
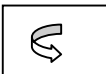
   
HOLD UNITS TARE OFF/ON

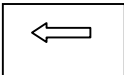
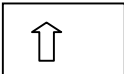
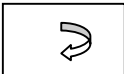
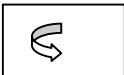
- (1)  Rotate the flashed position from right to left
- (2)  Change the digit on flashed position. The digit can be changed to 0, 1, 2...9; and be flashed.
- (3)  Confirm receiving and storing the displayed parameters, After the setting of the last parameter, the indicator will not exit the setup mode, and cycles from the first parameters for viewing or modifications.
- (4)  Exit from setting mode to normal work mode

3.4 In displaying A/D code or input voltage mode:

(1) No function

(2)

WT VOL

 Choose the weight inner code or input working voltage to be displayed. The working voltage range is 4.8V-8V. If the voltage is not within range, it may damage the indicator. Voltage value is shown like this “U x.xx” and its unit is V.

FLT

 When A/D code of weight is shown, press this button to choose filtered or un-filtered weight A/D data; when is on, the data is filtered.

(4)

EXT

 Press this button to exit this mode, and auto-reset the indicator, display all segments of LCD, full capacity... just like power on again and then it goes back to normal weighing mode.

3.5 Calibration mode

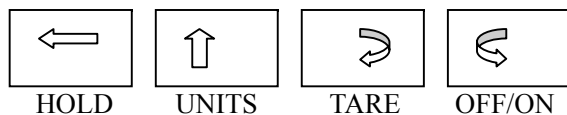

- (1)

--

 Rotate the flashed position from right to left
- (2)

--

 Change the digit on flashed position. The digit can be changed to 0, 1, 2...9; and be flashed.
- (3)

--

 Confirm receiving input data and go into next step.
- (4)

--

 Exit from calibration mode to normal work mode

III. CALIBRATION:

Before calibrate the scale, you should prepare a standard weight (more than 25% of FS weight, and the unit is same as P10 setting) for calibration.

1. Move away any weight on scale. When normal weighing mode, press and

hold down **TARE** and **ON/OFF/ZERO** buttons to enter calibration mode.

- 2. When the indicator shows” CAL-?”, the scale is ready for calibration. Press **TARE** to confirm and go to next step, or press **ON/OFF/ZERO** to exit the calibration mode.
- 3. The 140 indicator will display “CAP.--”, that means the following data is the full capacity according to your setting of display resolution (P7), display division value (P8) , location of decimal point-dot in calibration unit (P9) and capacity’s unit in calibration (P10). If the setting of FS is more than 199999 (regardless of decimal point and weight unit), the FS capacity will be shown by first four digits and last four digits: “Hxxx” and “Lxxx”.
For example, the display resolution is selected to 100000(P7=31), the display division is selected to 5(P8=2), the position of decimal point is selected to one point after zero (P9=1). The calibration unit is chosen as lb (P10=1), so the full capacity 50000.0lb will be shown as H 50 and L000.0 in lb unit. Also, in other modes, the data will be shown as “Hxxx” and “Lxxx” when current display data is larger than 199999 kg/lb (not include decimal point).

Press **TARE** to go to next step directly; press **ON/OFF/ZERO** to exit the calibration mode; or after a few seconds, it will automatically to next step.

- 4. The scale will automatically display the setting of division. Firstly it will display “d.--”, and then the data according to your setting of P8, P9 and P10. You may choose division among these as below:

Table1:

0.0001kg/lb	0.0002kg/lb	0.0005kg/lb
0.001kg/lb	0.002kg/lb	0.005 kg/lb
0.01kg/lb	0.02 kg/lb	0.05 kg/lb
0.1kg/lb	0.2 kg/lb	0.5 kg/lb
1kg/lb	2 kg/lb	5 kg/lb
10kg/lb	20 kg/lb	50 kg/lb

Press **TARE** to go to next step directly; press **ON/OFF/ZERO** to exit the calibration mode; or after a few seconds, it will automatically to next step.

- 5. When ‘CAL.P0’ is displayed, that means the scale will begin to calibrate

scale's zero-point. Move away any weight on the scale. Press **TARE** button to confirm, or press **ON/OFF/ZERO** to exit this mode.

6. When 'CAL.P1' is displayed, the scale will be calibrated on second calibration point. The default standard weight is 50%FS, and at the same, you can press **ON/OFF/ZERO** to exit the calibration mode. Or load 12.5%-100%FS weight, and use **PRINT/HOLD** and **UNIT** keys to input the loaded weight. If the input data is larger than 199999, it will show as "Hxxx" and "Lxxx". If the triangular symbol on the left bottom of LCD window appears, it means that the digit being changed is the displayed most significant bit which can only be 0/blank or 1. Press **TARE** key to confirm your setting and the indicator will flash the input standard weight. Wait till the scale comes steady, and input A/D data as per the standard weight.

The indicator will automatically go to next step, if the second point can be calibrated correctly. If there's an error occurred, the scale will display "CAL. Er" and return back to step 5 for re-calibration.

7. When 'CAL.P2' is displayed, the scale will be calibrated on third calibration point. When xxxxxx kg (or lb) is displayed (100% FS is default), you can press **ON/OFF/ZERO** to exit the calibration mode or Place a standard weight (must be in the range of 25%-100% FS, and equal or larger than that for the second calibration point; this is also the range of your input number) on the scale. Use **PRINT/HOLD** and **UNIT** key to input the standard weight's value. Use **TARE** key to confirm the standard weight and input number are correct. If the calibration weight for third point is same with that for second point and the calibration weight is more than 25%FS, input the standard calibration weight same as second point calibration and press **TARE** key to confirm the setting. The indicator will flash the input weight. If the indicator get reasonable data (the input weight is correct, and the calibration weight of third calibration is more than equal to the calibration weight of second calibration), it will go to next step automatically. If there's an error occurred, the scale will display "CAL. Er" and return back to step 5 for re-calibration.
8. When 'CAL.P0' is shown again, that means the scale will calibrate scale's zero-point again. Now, you can press **ON/OFF/ZERO** to exit the calibration mode; or Move away any weight on the scale, press **TARE** key to confirm;

the displayed data will blink. If the indicator gets reasonable data, it will calculate and store all parameters in EEPROM. And then it will auto-reset and display all segments of LCD, full capacity... like power on again. If there's an error occurred in calibration, the scale will display "CAL.Er" and try to repeat from step5. The scale will return to normal weighing mode.

IV. DISPLAY ADC CODE OR INPUT WORKING VOLTAGE VALUE

1. In normal weighing mode, press and hold down **ON/OFF/ZERO** and **HOLD/PRINT** key more than 3s, until 'code' is shown, this means you have been in display inner code mode; but first, the indicator will show the firmware version "xx.xx.xx". In this mode, you can examine the inner working voltage, the stability of weighing system, the variety value of A/D data as per the loaded weight.

NOTE:

- 1) The increment of A/D code for FS weight must be larger or equal to 2 times of selected display division-n; otherwise, the calibration cannot be properly completed. Eg. The display division is 0.1kg. Load 100kg standard weight on the platform, the increment of A/D code is at least $2 \times 100\text{kg}/0.1\text{kg} = 2 \times 1000 = 2000$. In this case, the scale can be calibrated. Otherwise, smaller division needs to be chosen.
 - 2) The data should be stable; otherwise, the calibration cannot properly complete.
2. In this mode, you can calculate the proper ADC data at zero point by examining the A/D data for loaded weight. If the ADC increase for full capacity is NFS, the power-on zero range is set to $Zp\%$ FS (P12 setting) and zero key range is set to $Zk\%$ FS (P13 setting). Then proper ADC data of zero point is larger than $(Zp\% + Zk\%) \times NFS$.

ADC increase for full capacity (NFS) can be making out by: Load the weight W on the platform, and the ADC increase for W weight is Nw. The ADC increase for full capacity WFS is $(NFS) = (Nw) \times (WFS)/W$.

Negative value may be displayed because of error connect of loadcell or error

position of the zero-point potentiometer on PCB; however, the software only deals with positive value. So, if you are the position of zero-point potentiometer is error; adjust potentiometer's position to make the ADC data will be positive value and larger than $(Z_p\% + Z_k\%) \times \text{NFS}$. Normally the indicator is factory-calibrated, and end users do not need this operation.

Below is the drawing of position of the zero-point potentiometer on PCB for reference, decrease ADC data by rotating clockwise, and increase ADC data by rotating counter-clockwise.

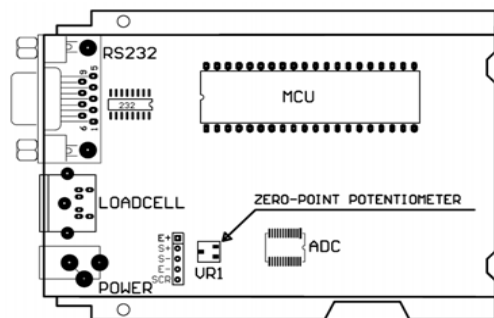

3. Press **UNIT** key to select displaying weight inner code or input the inner working voltage value. When the "U x.xx" is displayed, the display digit is voltage value, and the unit is V. The proper working power voltage is between 5V and 8V.
4. Press **TARE** key to display filtered or un-filtered weight A/D data; when **▶** is on, the data is filtered.
5. Press **ON/OFF/ZERO** key to exit this mode and return to normal weighing mode.

V. WORKING PARAMETER SETUP:

1. When scale is in normal weighing mode, press and hold down

ON/OFF/ZERO and **UNIT** key until 'SETUP' is shown, that means the scale is in SETUP mode.

2. This indicator has 19 kinds of parameters to be selected and setup by this function.
3. During SETUP mode, press **UNIT** key to change the flashed digits, and **HOLD/PRINT** key to shift the flashed position. Press **TARE** key to confirm and save the set data and enter next setting. Press **ON/OFF/ZERO** key to exit this mode.
4. Display
 - 1) P A.B: Item A parameters and one digit can be input.
 - 2) P A.BC: Item A parameters and two digits can be input
 - 3) PAB.C: Item AB parameters and one digit can be input
 - 4) PAB.CD: Item AB parameters and two digits can be input
5. Detailed setup:
 - 5.1) P1.xy: Auto-off time xy= 00-15
 00: means no auto-off function
 01-15: means the scale turns off to save power after 01-15 minutes when no variety of weight on scale and no key operation.
 - 5.2) P2.x: **HOLD/PRINT** key function definition
 x=0 means only HOLD function
 x=1 means only PRINT function
 x=2 means HOLD and PRINT function: short-time click the button once for Print function, and hold the button for several seconds for HOLD function
 - 5.3) P3.xy: Hold function setting
 Xy=0: No hold function;
 Xy=1: When the scale becomes stable, it will hold the larger weight reading;
 Xy=2: When the scale becomes stable, it will automatically display and hold the weight reading. When this weight is below 10d, HOLD function will automatically inactivated. When the new weight is more than 10d, the scale will hold the new weight when stable.
 Xy=3-50: When the weight variety is within the setting range $\pm 3\sim 50d$, the weight reading will remain unchangeable.

5.4) P4.x: RS232 mode setting

x=0: No RS232 function. It will not transmit or receive any data although the scale is with RS232 hardware. RS232 function can be only activated when scale is in normal weighing mode.

x=1: Press **PRINT/HOLD** key, the scale will output the current stable displayed weight reading and weight unit, and not receive any data from other equipment. The output format is as below:

<LF>< reading, minus, decimal point, weight unit><CR><EXT>

x=2: Press **PRINT/HOLD** key, the scale will output the data of stable current gross, tare, net weight reading and weight unit. The format is as follows:

<LF><Gross: reading, minus, decimal point, unit><CR><EXT>

<LF> <Tare: reading, decimal point, unit><CR><EXT>

<LF> <Net: reading, minus, decimal point, unit><CR><EXT>

The number of position used: weight reading ---7;

Minus ---1;

Decimal point ---1;

Weight unit ---2 or 4;

x=3: Continuously output of the current displayed reading and unit, and it does not receive any data. The output format is same as x=1.

x=4: Continuously output of the current gross weight, tare weight and net weight reading data including unit, and not accept any data. The output format is same as x=2.

X=5: When the scale is stable, it will output the current displayed weight reading automatically one time including unit, and not accept data.

The output format is same as x=1.

X=6: When the scale is stable, it will output the current gross weight, tare weight and net weight data including unit automatically one time, and not accept data. The output format is same as x=2.

X=7: Bio-RS232 data output compatible to the NCI-SP1 format.

5.5) P5.x: Baud rate of RS232 communication

x=0: 1200bps

x=1: 2400bps

x=2: 4800bps

x=3: 9600bps

x=4: 19200bps

5.6) P6.x: RS232 communication data format

x=0: 8N0 8 digits, no odd or even, 1 start bit, 1 stop bit

x=1: 7O1 7 digits, 1 odd, 1 start bit, 1 stop bit

x=2: 7E1 7 digits, 1 even, 1 start bit, 1 stop bit

5.7) P7.xy: calibration resolution

Table2:

xy	calibration resolution	xy	calibration resolution
00	500	16	7500
01	600	17	8000
02	750	18	10000
03	800	19	12000
04	1000	20	15000
05	1200	21	20000
06	1500	22	25000
07	2000	23	30000
08	2400	24	35000
09	2500	25	40000
10	3000	26	50000
11	3500	27	60000
12	4000	28	70000
13	5000	29	75000
14	6000	30	80000
15	7000	31	100000

5.8) P8.x: calibration division

x=0: 1

x=1: 2

x=2: 5

5.9) P9.x: decimal point in calibration mode

- x=0: no decimal ($\times 10^0$)
 x=1: one decimal digit ($\times 10^{-1}$)
 x=2: two decimal digits ($\times 10^{-2}$)
 x=3: three decimal digits ($\times 10^{-3}$)
 x=4: four decimal digits ($\times 10^{-4}$)
 x=5: no decimal point ($\times 10^1$)

5.10) P10.x: Calibration unit

- x=0: kg as calibration unit
 x=1: lb as calibration unit

As per the setting of P8, P9 and P10, following table is listed,

Table3: Kg calibration unit:

Calibration division value	Display division value in different weight unit that can be used		
	kg	lb	Lb:oz (oz)
0.0001kg	0.0001kg	0.0002lb	Not available
0.001kg	0.001kg	0.002lb	Not available
0.01kg	0.01kg	0.02lb	0.5oz
0.1kg	0.1kg	0.2lb	5 oz
1kg	1kg	2lb	Not available
10kg	10kg	20 lb	Not available
0.0002kg	0.0002kg	0.0005 lb	Not available
0.002kg	0.002kg	0.005 lb	0.1 oz
0.02kg	0.02kg	0.05 lb	1 oz
0.2kg	0.2kg	0.5 lb	Not available
2kg	2kg	5 lb	Not available
20kg	20kg	50 lb	Not available
0.0005kg	0.0005kg	0.001 lb	Not available
0.005kg	0.005kg	0.01 lb	0.2 oz
0.05kg	0.05kg	0.1 lb	2oz
0.5kg	0.5kg	1 lb	Not available
5kg	5kg	10 lb	Not available
50kg	50kg	Not available	Not available

Table4: Lb calibration unit:

Calibration division value	Display division value in different weight unit that can be used		
	kg	lb	Lb:oz (oz)
0.0001lb	Not available	0.0001lb	Not available
0.001 lb	0.0005 kg	0.001 lb	Not available
0.01 lb	0.005 kg	0.01 lb	0.2 oz
0.1 lb	0.05 kg	0.1 lb	2 oz
1 lb	0.5 kg	1 lb	Not available
10 lb	5 kg	10 lb	Not available
0.0002 lb	0.0001 kg	0.0002 lb	Not available
0.002 lb	0.001 kg	0.002 lb	Not available
0.02 lb	0.01 kg	0.02 lb	0.5 oz
0.2 lb	0.1 kg	0.2 lb	5 oz
2 lb	1 kg	2 lb	Not available
20 lb	10 kg	20 lb	Not available
0.0005 lb	0.0002 kg	0.0005 lb	Not available
0.005 lb	0.002 kg	0.005 lb	0.1 oz
0.05 lb	0.02 kg	0.05 lb	1 oz
0.5 lb	0.2 kg	0.5 lb	Not available
5 lb	2 kg	5 lb	Not available
50 lb	20 kg	50 lb	Not available

5.11) P11.x: select the weighing unit that may be chosen by pressing **UNIT**

- x=0: only kg
 x=1: only lb
 x=2: only lb: oz
 x=3: kg or lb
 x=4: kg or lb: oz
 x=5: lb or lb: oz
 x=6: kg, lb, or lb: oz

Above setting of units may not be available as per above tables in 5.10

5.12) P12.x: Power-on zero-point range

x=0: the range is set to calibration zero point (CAL.P0) $\pm 1\%$ FS
 x=1: the range is set to calibration zero point (CAL.P0) $\pm 2\%$ FS
 x=2: the range is set to calibration zero point (CAL.P0) $\pm 5\%$ FS
 x=3: the range is set to calibration zero point (CAL.P0) $\pm 10\%$ FS
 x=4: the range is set to calibration zero point (CAL.P0) $\pm 20\%$ FS
 x=5: the range is set to calibration zero point (CAL.P0) $\pm 50\%$ FS
 x=6: the range is set to calibration zero point (CAL.P0) $\pm 100\%$ FS
 x=7: No limitation

5.13) P13.x: Zero range for **ZERO** button after switch on

x=0 Power-on zero-point $\pm 1\%$ FS;
 x=1 Power-on zero-point $\pm 2\%$ FS;
 x=2 Power-on zero-point $\pm 3\%$ FS;
 x=3 Power-on zero-point $\pm 4\%$ FS;
 x=4 Power-on zero-point $\pm 5\%$ FS;
 x=5 Power-on zero-point $\pm 10\%$ FS;
 x=6 Power-on zero-point $\pm 20\%$ FS;
 x=7 Power-on zero-point \pm No limitation
 x=8 Power-on zero-point $\pm 1\%$ FS;
 x=9 Power-on zero-point $\pm 2\%$ FS;
 x=10 Power-on zero-point $\pm 3\%$ FS;
 x=11 Power-on zero-point $\pm 4\%$ FS;
 x=12 Power-on zero-point $\pm 5\%$ FS;
 x=13 Power-on zero-point $\pm 10\%$ FS;
 x=14 Power-on zero-point $\pm 20\%$ FS;
 x=15 Power-on zero-point \pm No limitation

If zero key can be activated, it can clear the tare weight. If zero point is above the setting range, the indicator will show “0 - - -”, and if zero point is below the setting range, “0 _ _ _ _” will be shown.

5.14) P14.x: select which zero point will be used when powered on and weight signal is within the power-on zero-point range:
 x=0: Choose current weight as current power-on zero point.
 x=1: Choose calibration zero point as power-on zero point
 x=2: Choose power-off zero-point as power-on zero point, and power-off tare weight as current tare weight.

5.15) P15.x: select which zero point will be used when powered on and weight signal is **NOT** within the power-on zero-point range:
 x=0: Choose current weight as current power-on zero point.
 x=1: Choose calibration zero point as power-on zero point
 x=3: Choose power-off zero-point as power-on zero point, and power-off tare weight as current tare weight.

5.16) P16.x: Zero tracking range

x=0: 0d, means no tracking
 x=1: $\pm 0.25d$
 x=2: $\pm 0.5d$
 x=3: $\pm 1d$
 x=4: $\pm 1.5d$
 x=5: $\pm 2d$
 x=6: $\pm 3d$
 x=7: $\pm 4d$
 x=8: $\pm 5d$

Choose the zero tracking range as per the stability of weighing system, accuracy and weight excursion. The normal setting is $\pm 0.5d \sim \pm 1.5d$.

5.17) P17.x: Data filter intensity

x=0 very weak
 x=1 weak
 x=2 middle
 x=3 strong

The larger the chosen digit is, data filter intensity is stronger, and the speed of data updating is lower. The normal setting is 2.

5.18) P18.x: Range of weight stability checking

x=0: $\pm 0.5d$
 x=1...9: $\pm 1d \sim \pm 9d$

If the variety of weight reading is within the setting range continuously for several times, the scale is recognized as stable. The normal setting is $\pm 1d \sim \pm 3d$.

5.19) P19.x: Overload range that can be displayed (when weight is larger than range, “ - - - - - ” will be shown):

x=0: S+0d
 x=1: FS+9d
 x=2: 101%FS
 x=3: 102%FS
 x=4: 105%FS
 x=5: 110%FS

x=6: 120%FS
 x=7: 150%FS
 x=8: 200%FS
 x=9: No limitation

VI. The detail about RS232:

1. *RS-232 connects between scale and Host:*

```

Scale -----Cable-----Host
(DB9 female)------(DB9 male)-----(DB9 female)------(DB9 male)
TXD 2 ----- 2 ----- 2 -----2 RXD
RXD 3 ----- 3 ----- 3 -----3 TXD
GND 5 ----- 5 ----- 5 -----5 GND
DSR 4 ----- 4 ----- 4 -----4 DTR
DTR 6 ----- 6 ----- 6 -----6 DSR
CTS 7 ----- 7 ----- 7 -----7 RTS
RTS 8 ----- 8 ----- 8 -----8 CTS
NC  1 ----- 1 ----- 1 -----1
NC  9 ----- 9 ----- 9 -----9
  
```

Note: The indicator DB9 female's pin4 and pin6 is shorted, pin7 and pin8 is shorted!

2. *When P4 is set to 7: the protocol of RS232 is compatible to with NCI-SP1, here is the details:*

2.1) The baud rate and data format is fixed as per P5 and P6 setting. Responses to serial commands will be immediate, or within one weight measure cycle of the scale. One second should be more than adequate for use as a time-out value by remote (controlling) device.

2.2) The length of the weight field will be 7 digit weight data, one for minus sign, one for decimal point, two for measure unit (e.g. "lb", "kg"). If the unit is lb:oz, another two for "lb" and one for a space (<sp>) after lb. Units of measure abbreviations are always lower case.

a) If the weight is overcapacity, the scale will return nine '^' characters (the field of minus sign, decimal point, weight data is filled by '^').

If the weight is under capacity, it will return nine '_' characters (the field of minus sign, decimal point, and weight data is filled by '_').

If the zero point is error, it will return nine ' ' characters.

b) The character will be '-' for negative weight or a space character for positive weight. Minus sign follows after the first digit.

c) Useless leading zero before digits is suppressed.

2.3) Key to symbols used

<LF> Line Feed character (hex 0AH)

<CR> Carriage Return character (hex 0DH)

<ETX> End of Text character (hex 03)

<SP> Space (hex 20H)

H1H2H3 Three status bytes

<p> Polarity character including minus sign for negative weight and a space character for positive weight

W1-W7 weight data

<dp> decimal point

U1U2: measure units, kg, lb, or oz

2.4) Commands and response

(1) Command: W<CR> (57h 0dh)

Response:

①<LF>~~~~~u1u2<CR><LF>H1H2H3<CR><ETX>---over capacity

②<LF>_____u1u2<CR><LF> H1H2H3 <CR><ETX>---under capacity

③<LF>-----u1u2<CR><LF> H1H2H3<CR><ETX>---zero-point error

Note: If the weight unit is lb: oz, U1U2= oz in above item ①②③.

④ <LF><p>w1w2w3w4w5w6<dp>w7u1u2<CR><LF>H1H2H3<CR><ETX>

---Scale is stable, and the current weight unit is kg or lb. With or without decimal point and the position is as per the P9 setting and current unit.

⑤<LF><p>w1w2w3w4w5lb<sp>w6w7<o><z><CR>H1H2H3<CR><ETX>

Or <LF><p>w1w2w3w4lb<sp> w5w6<dp>w7oz<CR>H1H2H3<CR><ETX>

----The current unit is lb: oz.

(2) Command: **S<CR>** (53h 0dh)

Response: <LF> H1H2H3<CR><ETX>

(3) Command: **Z<CR>** (5ah 0dh)

Response: Zero function is activated and it returns to current scale status. just like pressing **ZERO/ON/OFF** button:

<LF> H1H2H3<CR><ETX>

If ZERO function cannot be activated, it will return to current scale status.

(4) Command: **T<CR>** (54h 0dh)

Response: TARE function is activated, and then returns scale status. just like pressing **TARE** button:

<LF> H1H2H3<CR><ETX>

If TARE function cannot be activated, it will return to current scale status.

(5) Command: **U<CR>** (55h 0dh)

Response: Changes units of measure and return scale status with new units, just like pressing **UNIT** button. The new measure unit should be allowed to use as per P11 setting.

<LF>u1u2<CR><LF> H1H2H3<CR><ETX>

If the weight unit is lb:oz, U1U2= lb oz

(6) Command: **L<CR>** (4ch 0dh)

Response: If Hold function can be activated, it will enable/disable hold (lock) function, like the **HOLD** key is pressed, and returns scale status.

<LF> H1H2H3 <CR><ETX>

(7) Command: **X<CR>** (58h 0dh)

Response: power off the scale, just like press down the **ON/OFF** key to turn off the scale.

(8) Command: all others

Response: Unrecognized command

<LF>? <CR><ETX>

2.5) Output status bit meaning:

Table5: The status bits definition:

Bit	Byte 1 (H1)	Byte 2 (H2)	Byte 3 (H3)
0	0=stable	0= not under capacity	01=normal work mode 10= hold work mode
	1= not stable	1= under capacity	
1	0= not at zero point	0= not over capacity	00=not define 11= not define
	1= at zero point	1= over capacity	
2	always 0	always 0	0= gross weight
			1= net weight
3	0= eeprom OK	always 0	always 0
	1= eeprom error		
4	always 1	always 1	always 1
5	always 1	always 1	always 1
6	always 0	always 1	always 0
7	parity	Parity	parity

VII. Relationship of capacity and the setting of P7, P8 and P9:

Table6: (Capacity unit is kg or lb)

Resoluti on set by P7	Division set by P8 and P9 (P8=0)					
	0.0001	0.001	0.01	0.1	1	10
500	0.0500	0.500	5.00	50.0	500	5000
600	0.0600	0.600	6.00	60.0	600	6000
750	0.0750	0.750	7.50	75.0	750	7500
800	0.0800	0.800	8.00	80.0	800	8000
1000	0.1000	1.000	10.00	100.0	1000	10000

1200	0.1200	1.200	12.00	120.0	1200	12000
1500	0.1500	1.500	15.00	150.0	1500	15000
2000	0.2000	2.000	20.00	200.0	2000	20000
2400	0.2400	2.400	24.00	240.0	2400	24000
2500	0.2500	2.500	25.00	250.0	2500	25000
3000	0.30000	3.000	30.00	300.0	3000	30000
3500	0.3500	3.500	35.00	350.0	3500	35000
4000	0.4000	4.000	40.00	400.0	4000	40000
5000	0.5000	5.000	50.00	500.0	5000	50000
6000	0.6000	6.000	60.00	600.0	6000	60000
7000	0.7000	7.000	70.00	700.0	7000	70000
7500	0.7500	7.500	75.00	750.0	7500	75000
8000	0.8000	8.000	80.00	800.0	8000	80000
10000	1.0000	10.000	100.00	1000.0	10000	100000
12000	1.2000	12.000	120.00	1200.0	12000	120000
15000	1.5000	15.000	150.00	1500.0	15000	150000
20000	2.0000	20.000	200.00	2000.0	20000	200000
25000	2.5000	25.000	250.00	2500.0	25000	250000
30000	3.0000	30.000	300.00	3000.0	30000	300000
35000	3.5000	35.000	350.00	3500.0	35000	350000
40000	4.0000	40.000	400.00	4000.0	40000	400000
50000	5.0000	50.000	500.00	5000.0	50000	500000
60000	6.0000	60.000	600.00	6000.0	60000	600000
70000	7.0000	70.000	700.00	7000.0	70000	700000
75000	7.5000	75.000	750.00	7500.0	75000	750000
80000	8.0000	80.000	800.00	8000.0	80000	800000
100000	10.0000	100.000	1000.00	10000.0	100000	1000000

Table7: (Capacity unit is kg or lb)

Resolution set by P7	Division set by P8 and P9 (P8=1)					
	0.0002	0.002	0.02	0.2	2	20
500	0.1000	1.000	10.00	100.0	1000	10000
600	0.1200	1.200	12.00	120.0	1200	12000
750	0.1500	1.500	15.00	150.0	1500	15000

800	0.1600	1.600	16.00	160.0	1600	16000
1000	0.2000	2.000	20.00	200.0	2000	20000
1200	0.2400	2.400	24.00	240.0	2400	24000
1500	0.3000	3.000	30.00	300.0	3000	30000
2000	0.4000	4.000	40.00	400.0	4000	40000
2400	0.4800	4.800	48.00	480.0	4800	48000
2500	0.5000	5.000	50.00	500.0	5000	50000
3000	0.6000	6.000	60.00	600.0	6000	60000
3500	0.7000	7.000	70.00	700.0	7000	70000
4000	0.8000	8.000	80.00	800.0	8000	80000
5000	1.0000	10.000	100.00	1000.0	10000	100000
6000	1.2000	12.000	120.00	1200.0	12000	120000
7000	1.4000	14.000	140.00	1400.0	14000	140000
7500	1.5000	15.000	150.00	1500.0	15000	150000
8000	1.6000	16.000	160.00	1600.0	16000	160000
10000	2.0000	20.000	200.00	2000.0	20000	200000
12000	2.4000	24.000	240.00	2400.0	24000	240000
15000	3.0000	30.000	300.00	3000.0	30000	300000
20000	4.0000	40.000	400.00	4000.0	40000	400000
25000	5.0000	50.000	500.00	5000.0	50000	500000
30000	6.0000	60.000	600.00	6000.0	60000	600000
35000	7.0000	70.000	700.00	7000.0	70000	700000
40000	8.0000	80.000	800.00	8000.0	80000	800000
50000	10.0000	100.000	1000.00	10000.0	100000	1000000
60000	12.0000	120.000	1200.00	12000.0	120000	1200000
70000	14.0000	140.000	1400.00	14000.0	140000	1400000
75000	15.0000	150.000	1500.00	15000.0	150000	1500000
80000	16.0000	160.000	1600.00	16000.0	160000	1600000
100000	20.0000	200.000	2000.00	20000.0	200000	2000000

Table8: (Capacity unit is kg or lb)

Resolution set by P7	Division set by P8 and P9 (P8=2)					
	0.0005	0.005	0.05	0.5	5	50
500	0.2500	2.500	25.00	250.0	2500	25000
600	0.3000	3.000	30.00	300.0	3000	30000

750	0.3750	3.750	37.50	375.0	3750	37500
800	0.4000	4.000	40.00	400.0	4000	40000
1000	0.5000	5.000	50.00	500.0	5000	50000
1200	0.6000	6.000	60.00	600.0	6000	60000
1500	0.7500	7.500	75.00	750.0	7500	75000
2000	1.0000	10.000	100.00	1000.0	10000	100000
2400	1.2000	12.000	120.00	1200.0	12000	120000
2500	1.2500	12.500	125.00	1250.0	12500	125000
3000	1.5000	15.000	150.00	1500.0	15000	150000
3500	1.7500	17.500	175.00	1750.0	17500	175000
4000	2.0000	20.000	200.00	2000.0	20000	200000
5000	2.5000	25.000	250.00	2500.0	25000	250000
6000	3.0000	30.000	300.00	3000.0	30000	300000
7000	3.5000	35.000	350.00	3500.0	35000	350000
7500	3.7500	37.500	375.00	3750.0	37500	375000
8000	4.0000	40.000	400.00	4000.0	40000	400000
10000	5.0000	50.000	500.00	5000.0	50000	500000
12000	6.0000	60.000	600.00	6000.0	60000	600000
15000	7.5000	75.000	750.00	7500.0	75000	750000
20000	10.0000	100.000	1000.00	10000.0	100000	1000000
25000	12.5000	125.000	1250.00	12500.0	125000	1250000
30000	15.0000	150.000	1500.00	15000.0	150000	1500000
35000	17.5000	175.000	1750.00	17500.0	175000	1750000
40000	20.0000	200.000	2000.00	20000.0	200000	2000000
50000	25.0000	250.000	2500.00	25000.0	250000	2500000
60000	30.0000	300.000	3000.00	30000.0	300000	3000000
70000	35.0000	350.000	3500.00	35000.0	350000	3500000
75000	37.5000	370.000	3750.00	37500.0	375000	3750000
80000	40.0000	400.000	4000.00	40000.0	400000	4000000
100000	50.0000	500.000	5000.00	50000.0	500000	5000000

VIII. The meaning of some displayed symbols:

1. **0**----- zero point is over the setting range
2. **0**----- zero is below the setting range
3. **Ad**----- ADC is over max. range;

4. **Ad**----- ADC is below min. range;
5. ----- weight signal is too large
6. ----- weight signal is too small
7. **EEP.E0**----- the EEPROM can't be accessed;
8. **EEP.E1**-----The parameters are not same with backup data;
9. **EEP.E2**-----The setting parameter(s) is not in normal range;
10. **CAL-Px**-----scale's calibration point;
11. **CAL.Er**-----there is an error in calibration
12. **► Hold**-----hold function is active.
13. **Net** ◀----- The display reading is net weight
14. **Zero** ◀-----The scale is at zero point
15. **CAP.**-----The the setting full capacity will be displayed
16. **d.**-----The division will be displayed
17. **Px.y**----- The No. x parameter is set to y.
18. **Lo.bAt**-----The voltage of batteries or input power is below 4.7V

IX. The direction of indicator with bracket

The display is supplied with ABS plastic bracket, wall mounting vertically or bench mounting horizontally to read the weight display as following drawings.

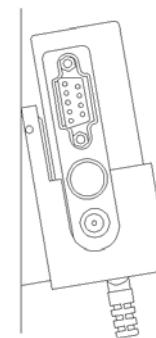

(1) Placed vertically

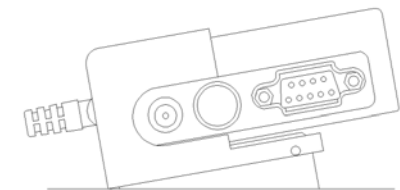

(2) Placed horizontally

X.Key Definition summary:

KEY	MODE	DEFINITION
HOLD /PRINT	Normal weighing mode	Enter or exit HOLD mode; output the data as per P4,P5,P6 setting
	Setup mode/Calibration mode	Shift the flashed position from right to left
	Displaying A/D code or input voltage mode	No Function
UNIT	Normal weighing mode	Choose weight units, refer P8, P9, P10, P11 setting and Table3, Table4.
	Setup mode/Calibration mode	Change the digit on flashed position and click this button to add 1.
	Displaying A/D code or input voltage mode	Choose the weight inner code or input working voltage to be displayed.
TARE	Normal weighing mode	Tare the weight
	Setup mode/Calibration mode	Confirm the displayed parameters or input data, and go to next step
	Displaying A/D code or input voltage mode	Choose filtered or un-filtered weight A/D data
ON/OFF/ ZERO	Normal weighing mode	Zero function or Power off the scale.
	Setup mode/Calibration mode/Displaying A/D code or input voltage mode	Exit and back to normal work mode
ON/OFF/ ZERO + HOLD /PRINT	Normal weighing mode (more than 3s)	Go to Show A/D code or input working voltage of indicator mode

ON/OFF/ ZERO + UNIT	Normal weighing mode (more than 3s)	Enter setup mode
ON/OFF/ ZERO + TARE	Normal weighing mode (more than 3s)	Enter calibration mode when

XI.Parameters setting summary: SEE SPECS

Para-meter	x/xy	Factory Set	Setting
P1.xy	00-15	05	Auto-off time: no auto-off; 01-15 minutes auto-off time
P2.x	0, 1, 2	2	0=only Hold function; 1=only Print function; 2=Print and Hold function.
P3.xy	0,1,2, 3-50	2	0=no hold function; 1=hold larger weight reading; 2=auto release hold function when weight is below 10d and auto-hold new stable weight (more than 10d); 3-50=unchangeable reading when the variety is within $\pm 3\sim 50d$
P4.x	0,1,2,3,4, 5,6,7	2	0=no RS232 function; 1=output display data when PRINT pressed; 2=output gross, tare and net weight when PRINT pressed; 3=continuously output display data; 4=continuously output gross, tare and net weight; 5=output display data one time when scale is stable; 6=output gross, tare and net weight one time when scale become stable; 7=Bio-RS232 compatible to NCI-SP1
P5.x	0, 1, 2, 3, 4	3	Baud rate for RS232: 0=1200bps, 1=2400bps, 2=4800bps, 3=9600bps, 4=19200bps
P6.x	0, 1, 2	0	RS232 format: 0=8N0, 1=7O1, 2=7E1

P7.xy	00-31	10	Resolution select: 500,600,750,800,1000,1200,1500,2000,2400,2500, <u>3000</u> , 3500, 4000, 5000, 6000, 7000, 7500, 8000, 10000, 12000, 15000, 20000, 25000, 30000, 35000, 40000, 50000, 60000,70000,75000,80000,100000
P8.x	0,1, 2	1	Division select: 0=1, <u>1=2</u> , 2=5
P9.x	0,1,2,3,4,5	1	Decimal point in calibration: 0= $\times 1$, <u>1=$\times 0.1$</u> , 2= $\times 0.01$; 3= $\times 0.001$; 4= $\times 0.0001$; 5= $\times 10$
P10.x	0, 1	1	Calibration unit: 0=kg, <u>1=lb</u>
P11.x	0, 1, 2, 3, 4, 5, 6	6	Weighing units enable: 0=only kg; 1=only lb; 2=only lb:oz; 3=kg or lb; 4=kg or lb:oz; 5=lb or lb:oz; <u>6=kg, lb, or lb:oz</u>
P12.x	0, 1, 2, 3, 4, 5, 6, 7,	7	Power-on zero-point range: 0=calibration zero -point $\pm 1\%$ FS; 1=calibration zero -point $\pm 2\%$ FS; 2=calibration zero-point $\pm 5\%$ FS; 3=calibration zero-point $\pm 10\%$ FS; 4=calibration zero-point $\pm 20\%$ FS; 5=calibration zero-point $\pm 50\%$ FS; 6=calibration zero-point $\pm 100\%$ FS; <u>7=No limitation</u>
P13.x	0,1,2,3,4,5,6,7, 8,9, 10, 11, 12, 13, 14, 15	4	Zero range for <u>ZERO</u> button: 0= Power-on zero-point $\pm 1\%$ FS; 1= Power-on zero-point $\pm 2\%$ FS; 2= Power-on zero-point $\pm 3\%$ FS; 3= Power-on zero-point $\pm 4\%$ FS; <u>4= Power-on zero-point $\pm 5\%$FS;</u> 5= Power-on zero-point $\pm 10\%$ FS; 6= Power-on zero-point $\pm 20\%$ FS; 7= Power-on zero-point \pm No limitation 8= Power-on zero-point $\pm 1\%$ FS; 9= Power-on zero-point $\pm 2\%$ FS; 10= Power-on zero-point $\pm 3\%$ FS; 11= Power-on zero-point $\pm 4\%$ FS; 12= Power-on zero-point $\pm 5\%$ FS; 13= Power-on zero-point $\pm 10\%$ FS; 14= Power-on zero-point $\pm 20\%$ FS; 15= Power-on zero-point \pm No limitation

P14.x	0, 1, 2	0	Weight signal within power-on zero point range, Choose which data as current power-on zero point; <u>0= current weight</u> ; 1= calibration zero-point; <u>2=switch-off zero-point</u>
P15.x	0, 1, 2	1	Weight signal not within power-on zero point range, Choose which data as current power-on zero point; 0= current weight ; <u>1= calibration zero-point</u> ; 2=switch-off zero-point; 3=continuously display "0 - - - -"
P16.x	0, 1, 2, 3, 4, 5, 6,7,8	4	Zero tracking range: 0=0d, no tracking; 1= $\pm 0.25d$; 2= $\pm 0.5d$; 3= $\pm 1d$; <u>4=$\pm 1.5d$</u> ; 5= $\pm 2d$; 6= $\pm 3d$; 7= $\pm 4d$; <u>8=$\pm 5d$</u>
P17.x	0, 1, 2, 3	2	Data filter intensity: 0=very weak, 1=weak, <u>2=middle</u> , 3=strong
P18.x	0, 1...9	1	Check weight stability range: 0= $\pm 0.5d$; 1= $\pm 1d$; 2= $\pm 1.5d$; 3= $\pm 2d$; 4= $\pm 3d$; 5= $\pm 4d$; 6= $\pm 5d$; 7= $\pm 6d$; 8= $\pm 7d$; 9= $\pm 8d$
P19.x	0, 1...9	3	Overload limit range: 0=FS+0d; <u>1=FS+9d</u> ; 2=101%FS; <u>3=102%FS</u> ; 4=105%FS; 5=110%FS; 6=120%FS; 7=150%FS; 8=200%FS; 9=No limitation



UK and Europe

Salter Brecknell Weighing

P.O. Box 9533

Smethwick

West Midlands

B66 2TE

Tel: +44 (0) 870 444 6132

Fa x : +44 (0) 870 010 2241

Email: sales@salterbrecknell.co.uk

Web site: www.averyweigh-tronix.com

USA

Salter Brecknell Weighing Products USA 1000 Armstrong Drive

Fairmont

MN 56031

Toll Free: 800-637-0529 Phone: 507-238-8702 Fax: 507-238-8271

Email: sales@salterbrecknell.com

Web site: www.salterbrecknell.com
