

Health o meter[®]

P r o f e s s i o n a l

Model 2000KL / 2000KG Stretcher / In-Bed Patient Scale



Equipped with
Everlock[®]

User Instructions



PELSTAR, LLC 9500 West 55th St. McCook, IL 60525-7110 USA

www.homscales.com

Health o meter[®] Professional 2000KL
Health o meter[®] Professional 2000KG

© Pelstar, LLC 2019

weigh**easier**[®]

Thank you for your purchase of this Health o meter® Professional product. Please read this manual carefully, and keep it for easy reference or training.

TABLE OF CONTENTS

Cautions and Warnings	3
Specifications	4
Certifications / Connectivity / Disposal	5
Assembly Instructions	6
Set-Up Instructions.....	13
Everlock® Instructions	17
Operating Instructions	18
Maintenance and Cleaning.....	23
Calibration	24
Troubleshooting	26
Warranty.....	27

Note: This scale has been factory calibrated, and does not require calibration prior to use.

Please register your scale for warranty coverage at:

www.homscales.com

For User Instructions updates and revisions please go to:

www.homscales.com

CAUTIONS AND WARNINGS

INTENDED USE

This Health o meter® Professional stretcher scale is intended to be used in a professional medical environment by trained medical staff. This product was designed to weigh patients who are safely positioned lying on the stretcher. Do not modify the product or use it for anything other than its intended purpose.

To prevent patient/caregiver injury or damage to your scale, please follow the instructions in this user manual very carefully.

- Do not exceed the weight capacity specified for this scale.
- For accurate weighing, this scale must be placed on a flat, stable surface.
- For accurate weighing, verify before each use the proper operation according to the procedure described in this manual.
- Do not use in the presence of flammable or explosive materials.
- If the scale becomes damaged, it should not be operated until properly serviced.
- Do not wheel or pull the scale down stairs, doing so may damage internal parts.
- Ensure that the AC adapter and scale do not come in contact with liquids, excessive temperature, or excessive humidity.
- For accurate weighing, the casters on the lifter base must be placed on a flat and stable surface with the stretcher not touching any surrounding surfaces.
- When transporting scale, do not push or pull on lifter mast. Move the scale by using steering handles only.

Patient/caregiver safety

- This scale is designed for static weighing of patients only. No scale should be used for patient transfer.
- To prevent patient injury, the patient must be attended throughout the entire weighing event. Caregivers should ensure that the patient is stable and provide support as needed when positioning the patient onto and off of the scale.
- For maximum safety, ensure stretcher is positioned above a bed or a similar surface.
- When weighing a patient, position the patient as close to the above the bed as possible.
- When weighting a patient, adjust lifter base in the widest position.
- Do not lock or block lifter base wheels while lifting. Wheels must roll freely when positioning a patient.

When operating the scale with the AC adapter:

- Operate this scale exclusively with the AC adapter that is provided (ADPT30). Use of an unspecified adapter will void the warranty, and can pose a serious safety hazard.
- Prior to using this scale, inspect the AC adapter cord for cracking / fraying, or for broken / bent plug prongs.
- Prior to using this scale, ensure that the AC adapter is plugged into an outlet with the rated voltage appropriate for operation.
- Ensure that the AC adapter outlet is wired to a circuit breaker or other protected power source.
- Unplug the AC adapter, and carefully store both the adapter and adapter cord before moving the scale.
- Operating this scale at voltages and frequencies other than specified can damage the equipment and will void the warranty.

When operating the scale with batteries:

- If the scale's battery icon indicates that the batteries are low replace the batteries or switch to the AC adapter as soon as possible.
- When replacing / inserting batteries, be sure to use all new batteries.

This equipment has been tested and found to comply with the EMC limits for the Medical Device Directive 93/42/EEC (EN 55011 Class A and EN 60601-1-2). These limits are designed to provide reasonable protection against harmful interference in a typical medical installation. The equipment generates, uses and may radiate radio frequency energy and, if not installed and used in accordance with these instructions, may cause harmful interference to other devices in the vicinity. There is no guarantee that interference will not occur in a particular installation. If this equipment does cause harmful interference with other devices, which can be determined by turning the equipment off and on, the user is encouraged to try to eliminate the interference by one or more of the following measures:

- Reorient or relocate the receiving device.
- Increase the separation between the equipment.
- Connect the equipment into an outlet on a circuit different from that to which the other device(s) is connected.
- Consult Customer Service or a field service technician for help.

In no event whatsoever shall Pelstar, LLC be liable for damages or injuries arising from or connected with the assembly, use, or misuse of its products.

SPECIFICATIONS

General

The Model 2000KL/2000KG stretcher scale uses highly sophisticated microprocessor technology. Each precision scale is designed to provide accurate, reliable and repeatable weight measurements. In addition, each scale is designed to provide the user with features that make the weighing process simple, fast, and convenient.

The 2000KL displays weight in pounds (lb) or kilograms (kg). The 2000KG displays weight in kilograms only. The scale can be powered using an AC adapter (ADPT30 included), or by 6 D batteries (not included).

Specifications

Capacity and Resolution	2000KL; 400 lb x 0.2 lb (181 kg x 0.1 kg) 2000KG: 181 kg x 0.1 kg	
Power Requirements	Adapter Model No. UE15WCP1-090050SPA, Part No. UE160714HKKK1-P Health o meter® Professional Model (ADPT30) (Included) Input: 100-240V – 50/60Hz, 500mA Output: 9.0V - - - 0.5A Or 6 D Batteries (Not Included)	
Environmental	Operating temperatures: 50°F to 95°F (10°C to 35°C) Storage temperatures: 30°F to 125°F (0°C to 50°C) Maximum Humidity: 85% RH	
Physical Dimensions	Product Footprint Width: 70" (1778 mm) Depth: 44 ½" (1130 mm) Height: 77" (1956 mm) (at highest extension of lift) Weight: 104 lb (47 kg)	Canvas Size Width: 70 ½" (1791 mm) Depth: 30" (762 mm)

Scale information can be found by pressing  and selecting "Scale Info" in the submenu. This screen provides model number, capacity, calibration weight, the most recent field calibration date, number of field calibrations and software version.

DEFINITION OF SYMBOLS



Attention: Consult Accompanying Documents



Caution



Do not dispose of this device in the domestic waste stream.



Type B Applied Parts



DC Power Supply

CERTIFICATIONS / CONNECTIVITY / DISPOSAL

Certification Descriptions

	<p>Pelstar, LLC has been officially certified as the manufacturer of Health o meter® Professional medical devices. The Pelstar, LLC quality assurance system covers the development, production, sales and service of medical scales and measuring systems.</p>
---	---

All Health o meter® Professional scales are manufactured in FDA-registered factories.

Connectivity Information

To enable reliable transmission of weight, height, and Body Mass Index (BMI) data, this scale is designed to connect to a computer, monitor, or other electronic device via USB or Pelstar wireless technology. This connectivity helps minimize a source of potential medical errors caused by incorrectly copying and then recording patient data. For more information regarding how to connect the scale to other electronic devices, please contact Health o meter® Professional Scales Technical Support, available during normal business hours at 1-800-638-3722.

Scale Disposal



This Health o meter® Professional scale must be disposed of properly as electronic waste. Follow the national, regional or local regulations which apply to you for disposal of electronic waste or batteries. Do not dispose of this device in the domestic waste stream.

ASSEMBLY INSTRUCTIONS

Before Assembly

Each 2000KL/2000KG stretcher scale is shipped disassembled in (3) separate cartons. Carefully inspect all cartons for shipping damage before unpacking. If damage is found, contact your shipper or a Health o meter® Professional representative immediately at 1-800-815-6615. Claims must be filed with the shipper as soon as possible after receipt of the packages. The following information details what you will find inside the cartons as you unpack the parts for assembly.

To prevent scratching any components, carefully remove parts from the cartons and unwrap the packing materials. Set the cartons aside for storage. To avoid damaging the scale parts when unpacking, do not use a box cutter, knife, scissors, or any sharp object to open the protective inner packaging.

Parts List

Carton 1

- (1) Stretcher holder
- (1) Lifter boom
- (1) Stretcher canvas
- (1) Scale display support
- (1) Load cell beam assembly
- (2) Stretcher hoop
- (1) Small brown box
- (1) Long white box

The small brown box contains:

- (1) Display assembly
- (1) AC adapter
- (1) User information
- (1) Long white box
- (1) Screwdriver

The long white box contains:

- (1) AC adapter holder
- (1) Stretcher retaining strap
- (1) Display bracket cover
- (2) Plastic bags

Plastic bag 1 contains:

- (1) 5mm Allen wrench
- (1) 4.5mm Allen wrench

Plastic bag 2 contains:

- (2) Fork joints
- Hardware for assembly

Carton 2

Connected hardware that includes:

- (1) Hydraulic pump assembly
- (1) Base adjustment lever
- (1) Lifter base

Carton 3

- (2) Stretcher bars

Tools Required

Phillips head screwdriver (included), Small flat head screwdriver (not included), Allen wrenches (included), Adjustable box wrenches (not included).

ASSEMBLY INSTRUCTIONS (CONT.)

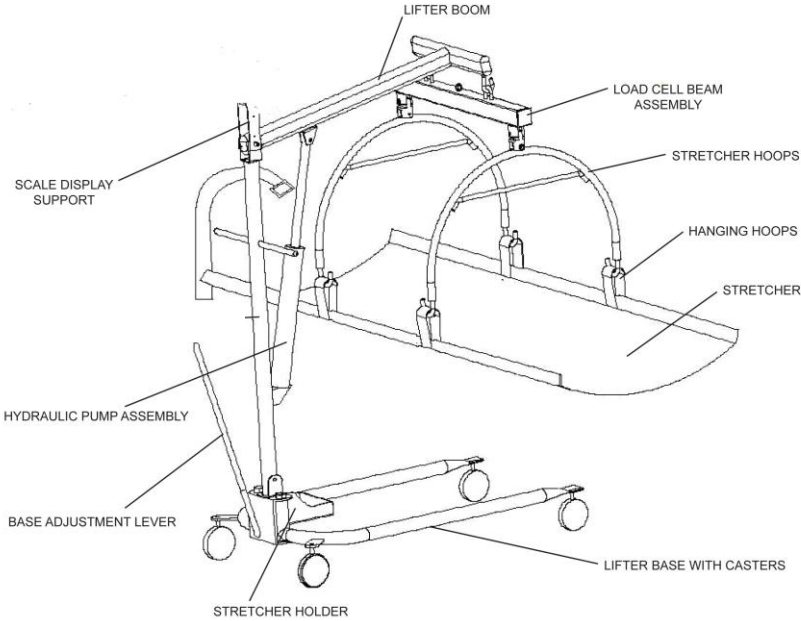
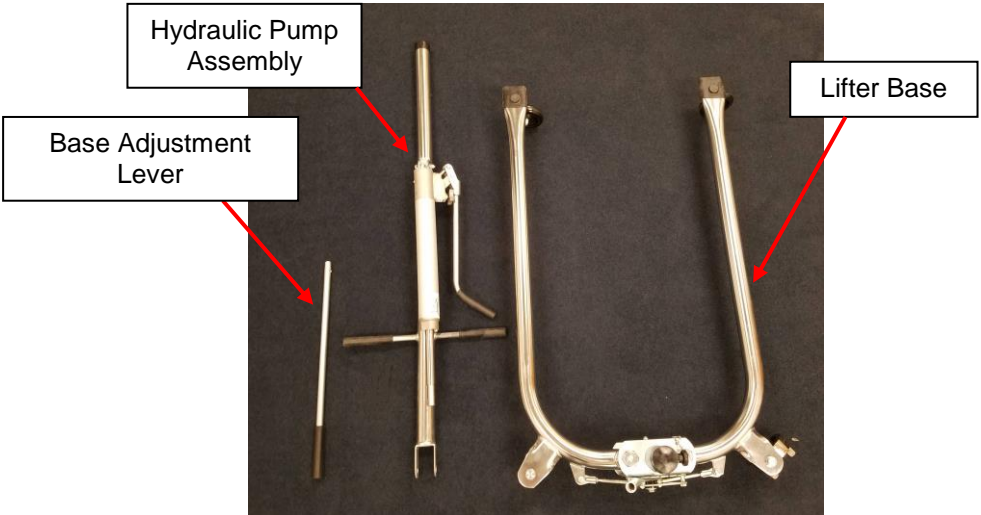
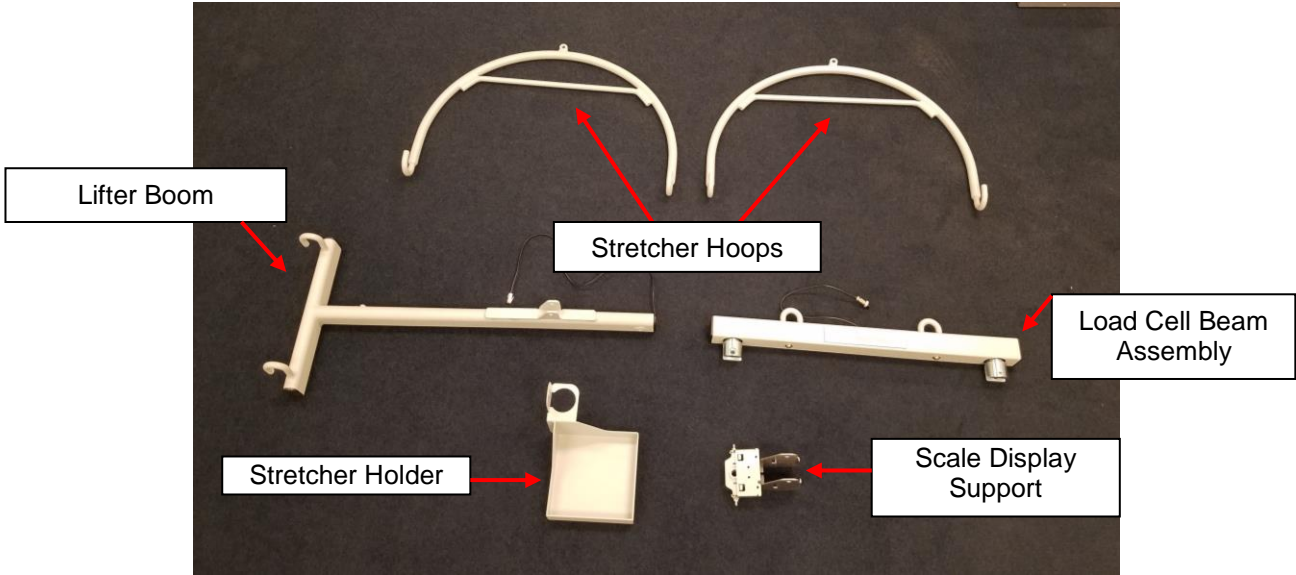

Assembly Layout

ASSEMBLY INSTRUCTIONS (CONT.)

Health o meter® Professional Scales recommends that assembly is performed by two people.

Assembling the Patient Lifter

1. Remove the lifter base from carton 2 and place the lifter base on a flat, level and dry surface. Remove the black plastic protective cap from the lifter mast. Locate the stretcher holder in carton 1 and place it onto the lifter base.

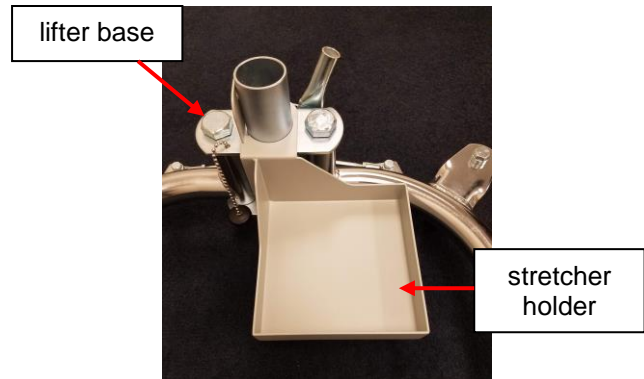

2. Insert the bottom of the hydraulic pump assembly into the pump sleeve on the lifter base. The notch on the end of the hydraulic pump assembly fits over the round tube at the bottom of the pump sleeve. Check that the pump assembly is locked into position, and that the hole in the pump assembly is aligned with the threaded hole in the pump sleeve. When assembled correctly, the pump assembly will not be able to rotate.

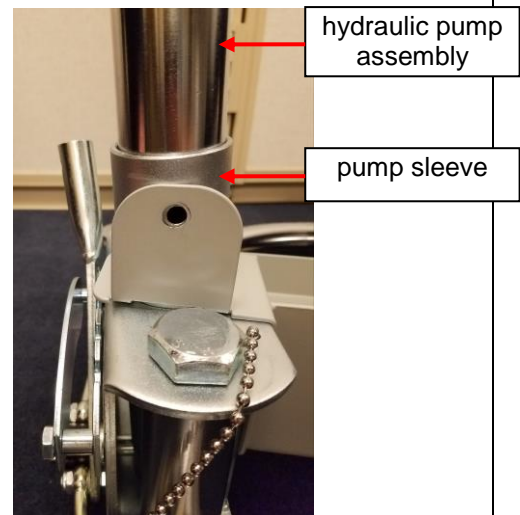

3. Screw the black thumb screw into the threaded hole in the pump sleeve. Tighten to lock the pump assembly to the lifter base.

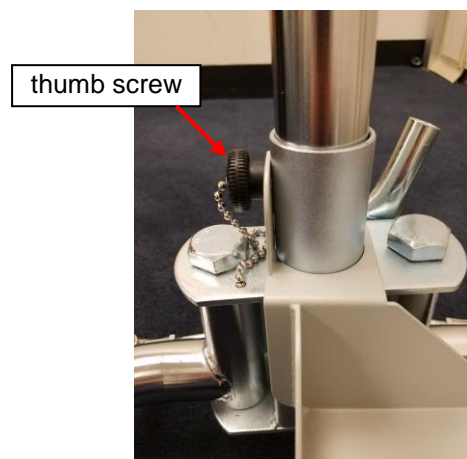

ASSEMBLY INSTRUCTIONS (CONT.)

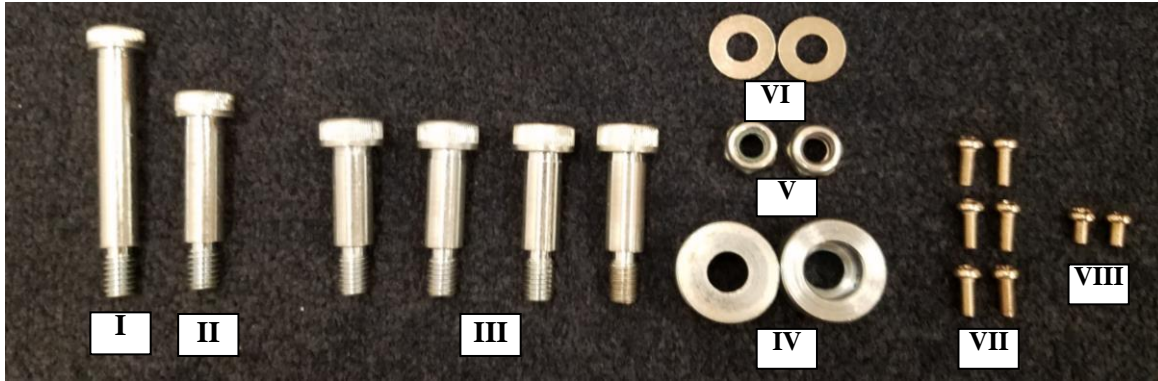

4. Locate the 3/8 – 20 x 2½” socket head screw (Hardware Item “I”) and one washer (Hardware Item “VI”). Locate the stretcher retaining strap from the long white box. Place the washer onto the socket head screw and insert the screw through the eyelet hole in the stretcher retaining strap. The screw can be inserted through either side of the strap. Obtain the self lock nut (Hardware Item “V”), the scale display support and the lifter boom. Have 1 person hold the lifter boom while the other person aligns the display support with the lifter boom and pump assembly. **Note:** Ensure that the lifter boom hooks are facing down during patient lifter assembly. Thread the screw with the retraining strap through the display support and lifter boom. Using an adjustable wrench or 13 mm box wrench along with an Allen wrench, tighten and secure the screw with the self lock nut.

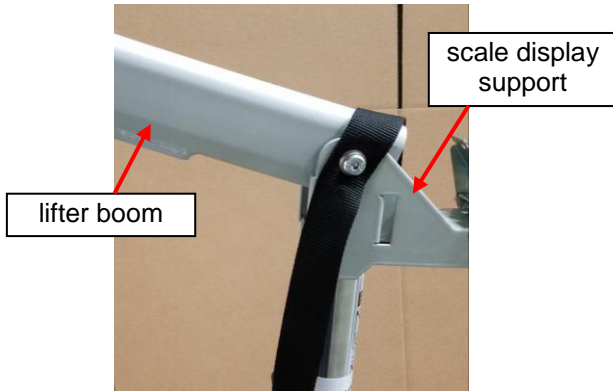

5. Locate the 3/8 – 20 x 1 ¾” socket head screw, self lock nut and washer (Hardware Items “II”, “V” and “VI”). Insert the end of the hydraulic pump shaft into the lifter boom’s bracket, and align the assembly holes. Place the washer onto the socket head screw and thread the screw through the lifter boom bracket and the hydraulic pump shaft hole. Secure the screw with the self lock nut.

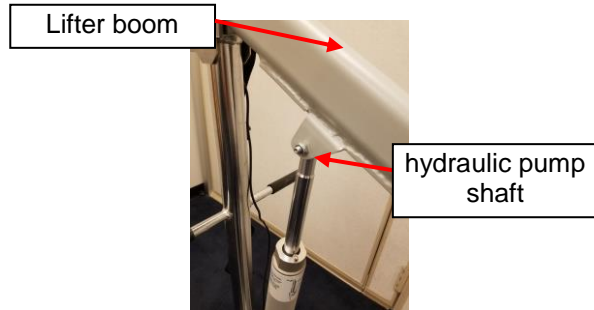

6. Insert the base adjustment lever into its socket at the back of the lifter base. Check to see that the positioning ball on the outside of the base of the adjustment lever fits securely in the socket.



ASSEMBLY INSTRUCTIONS (CONT.)

Mounting the Display Head

1. Obtain the display head and align the tab slots on the back of the display head with the tabs on the scale display support.

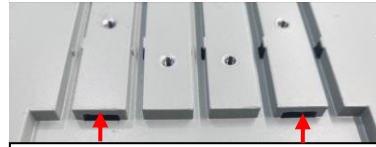

Slots on back of display head



Slide slots onto tabs in bracket

2. Align the four holes on the back of the display head with the four mounting holes on the silver display support. Using four of the Phillips pan head screws (Hardware item "VII"), fasten the display head onto the display support using a Phillips head screwdriver to tighten the screws.



3. Feed the load cell cable through the hole in the display support and then up through the mounting bracket. Plug the load cell cable into the load cell port on the rear of the display head.

Note: color of cable may vary.



4. Obtain the plastic bracket cover. Clip the load cell cable into the divot in the middle of the cover and align the cover over the silver display support. Clip the tabs on the cover into the display head. Obtain two Phillips pan head screws (Hardware item "VII") and attach the bracket cover using a Phillips head screwdriver.



ASSEMBLY INSTRUCTIONS (CONT.)

Attaching the Load Cell Beam Assembly and Stretcher Hoops

1. Hang the load cell beam assembly on the two hooks at the end of the lifter boom, using the loops on top of the load cell beam assembly.



2. Connect the end of the load cell beam cable to its port on the side of the lifter boom.



3. Place the lock rings (Hardware items "IV") onto the two hooks at the end of the lifter boom, using a small flat head screwdriver to tighten the set screws located inside the lock ring.



4. Use the socket head shoulder screws (Hardware items "III") to connect the fork joint to the load cell beam assembly. Tighten using an Allen wrench.



ASSEMBLY INSTRUCTIONS (CONT.)

5. Use the remaining two socket head shoulder screws (Hardware items “III”) to connect the two stretcher hoops to the load cell beam assembly and securely tighten. Make sure that the stretcher hooks face each other in the inward position.

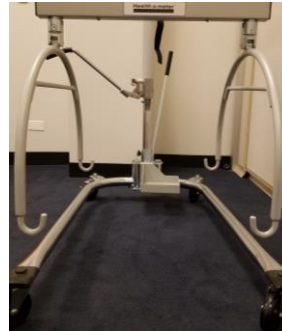

6. Insert the stretcher bars into the stretcher channel pockets on either side of the stretcher canvas. Confirm that the stretcher bars pass through the two hanging loops on each side of the stretcher canvas. Ensure that both ends of the channel pockets are sealed, by squeezing the Velcro strips together. The scale is now assembled. See Powering the Scale on page 13 for battery/AC adapter instructions. If powering the scale via AC adapter, see the next step for attaching the adapter holder.

Note: The hanging loops are tethered to the stretcher fabric. Make certain that each stretcher bar passes through the hanging loops. The other portion of the hanging loop will go over the hooks of the stretcher hoops.



7. **Optional Step – For powering the scale via AC power adapter.** The AC adapter holder can be attached to the scale behind the display head on the display support. Use two smaller Phillips pan head screws (Hardware item “VIII”) to secure the adapter holder to the scale.



SET-UP INSTRUCTIONS

Powering the Scale

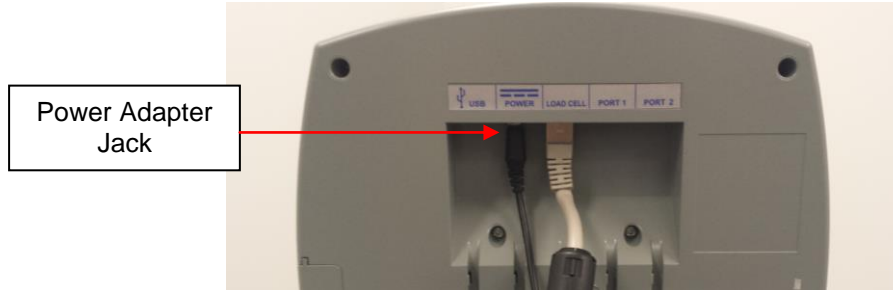

Plug the AC adapter into the power adapter jack (the jack is located on the rear of the display head), then plug the scale's AC adapter into the power source.

Warning: To avoid a safety hazard, do not use an unspecified AC adapter. Only use the Health o meter® Professional AC adapter model ADPT30 designed for this scale.



For battery operation, see Battery Installation below.

Battery Installation

<p>1. If connected, unplug the AC adapter from the power source. Use a Phillips head screwdriver to remove the battery cover on the side of the display head by unscrewing the battery cover screw.</p>	 <p>The image shows a close-up of the side of the scale with a callout box labeled "Battery Cover" pointing to a screw being removed from the battery cover.</p>
<p>2. Remove the battery pack from the display head. Replace or install fresh batteries, making sure to install them in the proper direction. Health o meter® Professional recommends using an alkaline battery rated for 130°F (54°C) operation. Do not use Zinc-Carbon batteries.</p>	 <p>The image shows the battery pack being removed from the scale and a separate image of four Energizer batteries.</p>
<p>3. Re-insert the battery pack into the display head, ensuring the end with the silver contacts is inserted facing the inside of the display. Re-attach the battery cover to the display head by replacing the battery cover screw.</p>	 <p>The image shows the battery pack being inserted into the scale and the battery cover being re-attached.</p>

Warning: If the scale will not be used for some time, remove the batteries to avoid a safety hazard. Disposal of batteries must be performed in accordance with the prevailing national, regional or local regulations that apply to you.

SET-UP INSTRUCTIONS (CONT.)

Unit of Measure Configuration / Unit Lock

(This feature is not available on KG models)

The weight measuring unit (pounds/LB or kilograms/KG) can be changed by pressing **Unit**. Follow this procedure to lock the weight measuring unit into LB or KG only.

1. Press **Help** to access the Help menu options.
2. While in the Help menu, press **↓** to select “Set Options”. Press **→** to advance to the next menu.
3. “Units Lock” is the first setting listed in the “Set Options” sub-menu. With “Units Lock” highlighted in red, press **→** to change the “Units Lock” option. Choose “Unlocked”, “LBS Locked”, or “KG Locked”.

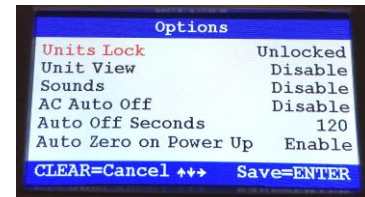

Note: You must press **Enter** to save your selection.

Note: To permanently lock the weight measuring unit, see the Everlock[®] section on page 17.

Enabling Unit View with Unit of Measure Locked

(This feature is not available on KG models)

If the scale is locked per the instructions above, users can still view the alternate weight measuring unit by enabling the “Unit View” option. Enabling the “Unit View” option allows the user to press the **Unit** button to briefly display the weight in the alternate weight measuring unit. After releasing the **Unit** button the display will return to the locked weight measuring unit. The “Unit View” default setting is “Disable”. Follow this procedure to enable “Unit View” when the weight measuring unit is locked.

Note: If Everlock[®] is engaged this feature is not available and the setting will show as “Everlocked”.

1. Press **Help** to access the Help menu options.
2. While in the Help menu, press **↓** to select “Set Options”. Press **→** to advance to the next menu.
3. While in the “Set Options” sub-menu, press **↓** to scroll through the options until “Unit View” is highlighted in red.
4. Press **→** to change the “Unit View” option. Choose “Enable” to allow the user to view the weight in the alternate weight measuring unit. Choose “Disable” to completely disable the **Unit** button when weight measuring unit is locked.

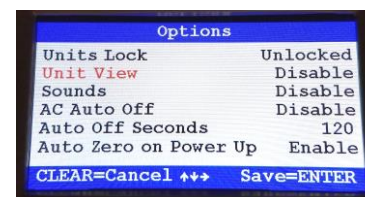

Note: You must press **Enter** to save your selection.

SET-UP INSTRUCTIONS (CONT.)

Setting Sound Options

The display can be set to stay silent or beep while operating the scale. Follow this procedure to set the preferred option.

1. Press **Help** to access the Help menu options.
2. While in the Help menu, press **↓** to select “Set Options”. Press **→** to advance to the next menu.
3. While in the “Set Options” sub-menu, press **↓** to scroll through the options until “Sounds” is highlighted in red.
4. Press **→** to change the “Sounds” option. Choose “Disable” for the display to stay silent while operating the scale. Choose “Enable” for the display to beep while operating the scale.

Note: You must press **Enter** to save your selection.

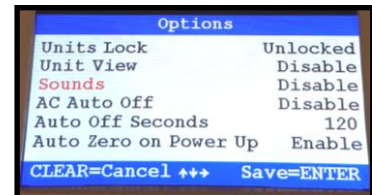

Activating/Deactivating AC Auto Off

When powering the scale via the AC adapter, the display can be set to power off after a period of inactivity. Follow this procedure to set the preferred option. **Note:** When powering the scale via batteries, the scale will automatically power off after a period of inactivity. See the next section to set the preferred time of inactivity before power off.

1. Press **Help** to access the Help menu options.
2. While in the Help menu, press **↓** to select “Set Options”. Press **→** to advance to the next menu.
3. While in the “Set Options” sub-menu, press **↓** to scroll through the options until “AC Auto Off” is highlighted in red.
4. Press **→** to change the “AC Auto Off” option. Choose “Enable” for the display to turn off after a period of inactivity. Choose “Disable” for the display to always remain on.

Note: You must press **Enter** to save your selection.

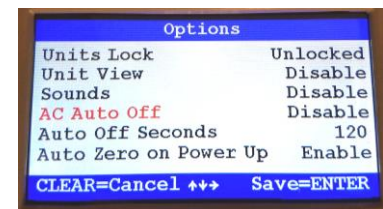
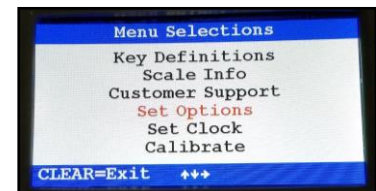

Setting Auto Off Timer

When powering the scale via batteries or if Auto Off is Enabled for the AC adapter, the period of inactivity before the scale powers off can be set to a specific amount of time. Follow this procedure to set the amount of seconds of inactivity before power off.

1. Press **Help** to access the Help menu options.
2. While in the Help menu, press **↓** to select “Set Options”. Press **→** to advance to the next menu.
3. While in the “Set Options” sub-menu, press **↓** to scroll through the options until “Auto Off Seconds” is highlighted in red.
4. Press **→** to change the “Auto Off Seconds” option. Choose from 60, 90, 120, 150, 180 or 600 seconds. 600 seconds is recommended to provide sufficient time to load the patient onto the stretcher.

Note: You must press **Enter** to save your selection.

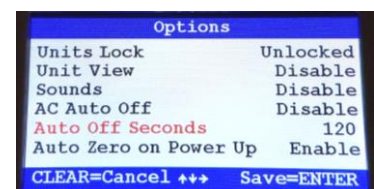





SET-UP INSTRUCTIONS (CONT.)

Setting Auto Zero Option

When a scale is set to zero, it creates a reference point for weights that are placed on it. There are two approaches to how this can take place. This option allows the user to select whether the scale will re-set itself to ZERO each time it is powered up or whether it will use the zero reading from the last time it was zeroed.



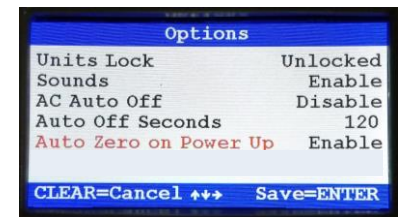

- “Enable” means the scale will zero itself when it is powered on and this may take a few seconds. After each use, the scale will clear the weight of the patient and set itself back to the initial ZERO level it found on start-up. Health o meter[®] Professional recommends keeping this setting as Enable. **Note:** Hitting a key to wake the scale from sleep mode will not prompt the scale to zero.
- “Disable” means the scale does not attempt to find a zero when powered on, rather it will use the last zero setting it had from its most recent use. There will be no delay in using the scale if the Auto Zero is disabled. Health o meter[®] Professional recommends that if the Disable option is selected, users should manually zero the scale before each weight measurement by pressing . Users will see dashes appear on the screen as the scale is finding zero.

1. Press  to access the Help menu options.
2. While in the Help menu, press  to select “Set Options”. Press  to advance to the next menu.
3. While in the “Set Options” sub-menu, press  to scroll through the options until “Auto Zero on Power Up” is highlighted in red.
4. Press  to change the “Auto Zero on Power Up” option. Choose from Enable or Disable.

Note: You must press  to save your selection.



Setting Date and Time

1. Press  to access the Help menu options.
2. While in the Help menu, press  to select “Set Clock”. Press  to advance to the next menu.
3. Use  and  to set the time and date.

Note: You must press  to save the information.

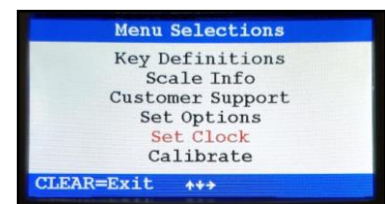

EVERLOCK® INSTRUCTIONS





Everlock®

(This feature is not available on KG models)

The Everlock® feature allows the scale to be permanently locked in KG (metric) or LB (imperial) units. When activating this feature, the **Unit** button will become disabled. This lock is permanent and can only be reversed at the factory.

This procedure engages Everlock® and will permanently lock the scale into LB or KG.

Warning: This lock is permanent and can only be reversed at the factory. If you need to change the units on your scale after Everlock® has been engaged, contact Health o meter® Professional Scales Customer Service at 1-800-815-6615.

1. Press  to access the Help menu options.
2. While in the Help menu, press  to select “Set Options”. Press  to advance to the next menu.
3. While in the “Set Options” sub-menu, press  to scroll through the options until “Everlock” is highlighted in red.
4. Press  to begin the Everlock® procedure.

To exit the procedure without engaging Everlock® press 

5. The screen will prompt you to enter the password. Use the arrows keys to enter the password as follows:



6. Use the up and down arrow keys to select “Everlock LB” or “Everlock KG”, press  to advance to the next step.

7. The screen will display a warning. To proceed with locking the weight measuring unit, use the arrow keys to enter the password as follows:



8. The weight measuring unit is now locked. The Options screen will now show “Units Lock” and “Unit View” as “Everlocked” and those settings cannot be changed by any user.

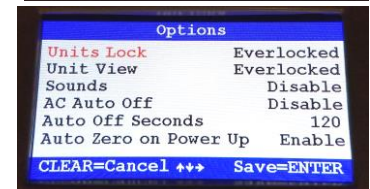
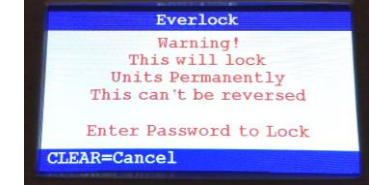
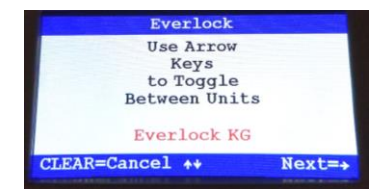
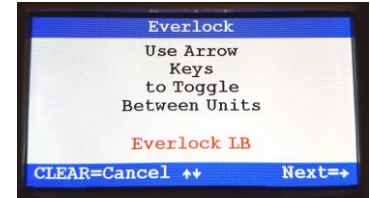
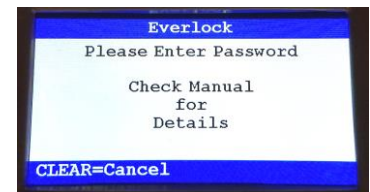
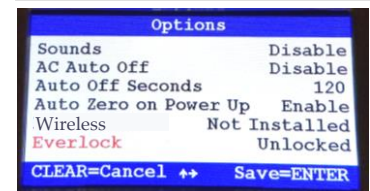
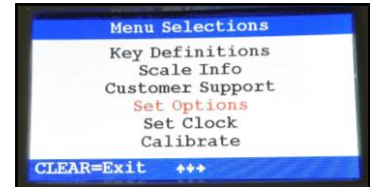











OPERATING INSTRUCTIONS

Key definitions can also be found by pressing **Help** and selecting “Key Definitions” in the submenu.



Keypad

Function	Description
	Powers scale on and off.
	Zeroes the scale prior to a weighing. Also used as a screen navigation key to exit a display menu.
	Holds the weight value on the display until the button is pressed again to clear the value.
	Prompts entry of height data to calculate patient’s Body Mass Index (BMI).
	Recalls the previous weight.
	TARE-Deducts the weight of an object on the platform. PRETARE-When held for 3 seconds, prompts entry of a weight value to be deducted from the weight on the platform. Also releases tare weight (returns display to zero).
	Toggles between pounds and kilograms. If weight measuring unit is locked and Unit View setting is enabled, press and hold Unit button to briefly display the alternate weight measuring unit. Note: the Unit button is disabled on KG models or on KL models with Everlock® engaged or with the “Unit View” setting disabled.
	Allows repeated weighing of the patient without stepping off the scale.
	Used to accept height value in BMI mode, and tare value in PRETARE mode. Also used to save selections in Set Options menu.
	Display navigation keys.



OPERATING INSTRUCTIONS (CONT.)

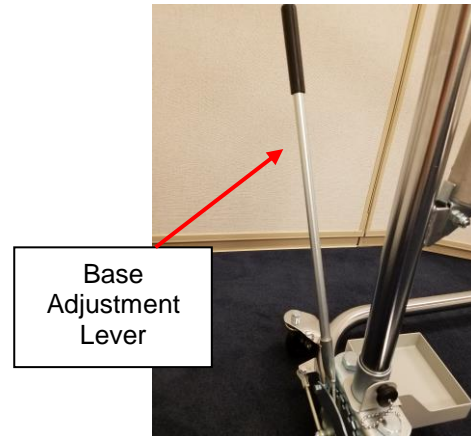
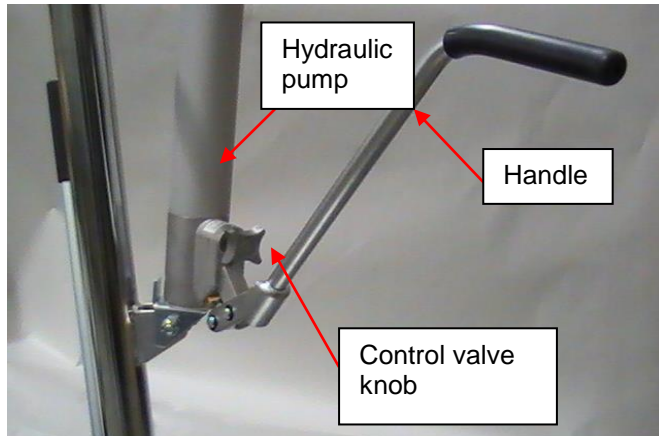

Loading the Patient onto the Stretcher



IMPORTANT: Keep the scale powered off while positioning the patient on the stretcher and preparing the scale to weigh.

IMPORTANT: BEFORE WEIGHING THE PATIENT, THE WEIGHT OF THE STRETCHER MUST BE TARED.

Caution: Never transport patient while on scale; never leave a patient unattended while he or she is on the scale.

1. Use the Base Adjustment Lever to widen the lifter base. The base must be spread to the widest possible position to maximize the scale stability when lifting the patient. To adjust the lifter base, unlock the legs by pulling back on the adjustment lever. Move the lever to the right in order to widen the base.
2. Use the hydraulic pump handle to raise the stretcher hoops above the approximate level of the patient.
3. Lay the stretcher on a bed or any other flat, stable surface. Place the patient onto the stretcher. **Note:** The patient's center of mass should be placed as close as possible to the center of the stretcher.
4. Wheel the scale close to the stretcher and the patient. Lower the lifter boom and stretcher hoops to within 5-10 inches (12-25 cm) of the patient. To lower the lifter boom, slowly turn the control valve knob counterclockwise. The rate of descent can be controlled by varying the knob's position. The lifter boom may not lower readily without weight. **Note:** If screws, mounting pump, or lifter mast are too tight, the lifter boom may not lower properly.
5. Before connecting the stretcher to the scale and weighing the patient, the weight of the stretcher must be tared. Follow the procedure below to tare the weight of the stretcher and weigh the patient.

Weighing a Patient

1. Press  to turn on the scale. Wait until "0.0" appears on the display.
2. Press and hold  for approximately 3 seconds. The display will change and prompt entry of the weight value to be tared. Use the arrow keys to enter to enter the weight of the stretcher: 10.2 lbs (4.6 kg). Press  to save the tare value.
3. The scale will zero and the tare value will show as a negative weight on the display. The word "TARE" will also appear at the bottom center of the display along with the tare value.

OPERATING INSTRUCTIONS (CONT.)

4. Connect the hanging loops of the stretcher to the hooks at the end of each set of stretcher hoops, making sure the loops hang properly and equally from the hooks. **Note:** Ensure the stretcher hanging hoops are properly attached to the end of the hooks. If not, an inaccurate reading could result.

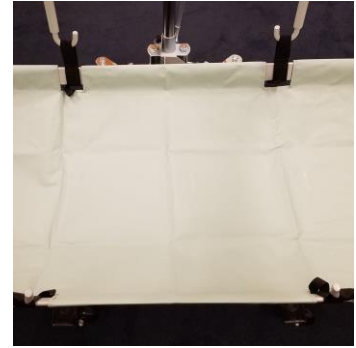

5. Tighten the hydraulic control valve knob by turning it clockwise. The control valve knob is located on the pump near the pump handle.
6. SLOWLY pump the hydraulic pump handle to lift the stretcher and patient until the entire stretcher is hanging from the loops and is not touching any surface below or any object around it. To operate the hydraulic pump, pump the handle in an upward and downward motion to elevate the lifter boom. Make certain the control valve knob (located on the hydraulic pump near the handle) is fully tightened clockwise. This enables the hydraulic pump to be operational. If needed, the base will move slightly or adjust for balance.
Warning: Never lock casters or block casters when lifting a patient. Locking the casters could cause the lift to tip and endanger the patient and assistants.
7. When the stretcher is stable and not moving the weight of the patient will appear on the scale. The scale will automatically deduct the tare value from the weight of the patient. The display will show the patient's weight.
8. The weight may be held on the display by pressing **Hold/Release**. The scale will continue to display the patient's weight after they are off the scale and will remain on the display until released or the scale is powered off. To release, press **Hold/Release**.
9. To reweigh the patient without removing them from the scale, press **Reweigh**.
10. To see the patient's weight in another unit of measurement, press and hold down **Unit**. If the scale is in LB mode, it will convert the weight to KG. If the scale is in KG mode, it will convert the weight to LB. **Note:** This function is not available on KG models or on KL models with Everlock® engaged or with the "Unit View" setting disabled.
11. After the weight measurement is recorded, lower the stretcher and patient slowly back to their bed or other flat, stable surface by opening the hydraulic pump control valve by turning the knob counterclockwise VERY slowly, to control the descent.
12. Guide the patient on the stretcher carefully down to the bed or flat, stable surface.
IMPORTANT: Ensure the hydraulic pump handle is not close to the stretcher so the stretcher does not get caught when lowering the patient.
13. Once the patient is resting on the bed, release the hanging loops from the stretcher hoops,
14. With no weight on the scale, the tare value will remain on the display until changed, cleared, or until the scale is turned off.
15. To remove the Tare, press **Tare** again. The word "TARE" will disappear from the display and the tare value will be cleared from the display.

OPERATING INSTRUCTIONS (CONT)

Weight Recall

1. To recall the last weight measured, press **Recall** .
2. To clear the display of the recalled weight, press **Zero (Clear)** .



BMI Function

1. Make sure there is no weight on the stretcher and the display shows “0.0”.
2. Follow weight measuring procedure. After obtaining the patient’s weight, and with the patient remaining on the scale, press **BMI** .
3. The scale will prompt entry of the patient’s height. Use the arrow keys to enter the patient’s height.

Note: When weighing in pounds, the height is displayed in inches. When weighing in kilograms, the height is displayed in centimeters.

4. Once height is keyed in, press **Enter** .
5. The display will show the patient’s BMI.
6. Press **Zero (Clear)** to return to the normal weighing mode.



OPERATING INSTRUCTIONS (CONT)

Moving the Scale

A caster lock is provided on the lifter base to prevent movement. To lock caster, use your foot to push down the side marked "ON". To unlock, use your foot to push down on the side marked "OFF".

Warning: Never lock caster lock or block casters when lifting a patient.

Note: Caster lock is provided for preventing mobility only.

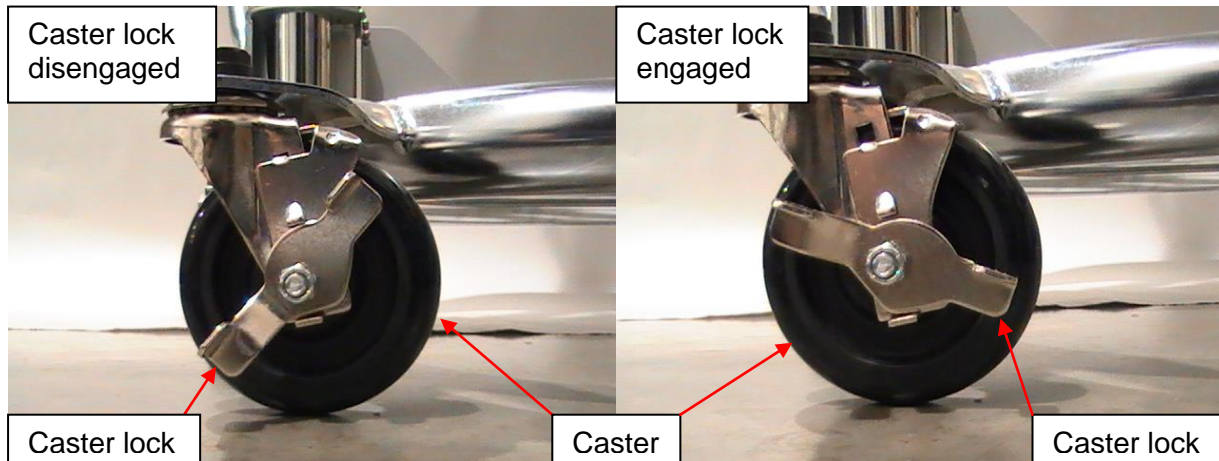

MAINTENANCE AND CLEANING

Maintenance

The following pages provide instructions for maintenance, cleaning, calibration, and troubleshooting for your scale. Maintenance operations other than those described in this manual should be performed by qualified service personnel.

Caution: Before first use, or after long periods of non-use, check the scale for proper operation and function. If the scale does not operate correctly, refer to qualified service personnel.

1. Check the overall appearance of the scale for obvious damage, wear, and tear.
2. Inspect the AC adapter cord for cracking, fraying, and for broken/bent prongs.

Cleaning and Disinfecting

Proper care and cleaning is essential to ensure a long life of accurate and effective weighing.

Caution: Disconnect the scale from the AC adapter power source prior to cleaning the unit.

These cleaning instructions apply to the scale parts only, not the stretcher.

1. Health o meter[®] Professional recommends using one of the following solutions on a soft cloth or disposable wipe:
 - mild soap and water solution
 - 70% isopropyl alcohol
 - solution with 1-5% hydrogen peroxide concentration

After cleaning/disinfecting, wipe with a cloth dampened with water and then with a clean dry cloth. To avoid residue build-up or damp surfaces, ensure the screen and scale parts are completely dry after cleaning.

2. Never use rough or abrasive materials to clean the scale, as these will damage the scale's finish.
3. Do not submerge the scale in water or any other liquid.
4. Do not pour or spray fluids directly on the scale.

Note: The stretcher fabric is made of laminated vinyl (PVC) with a poly urethane coating. Laundering is not recommended.

Replacement Parts

Parts may be available if a piece of the scale needs to be replaced. Contact Health o meter Professional Scales Customer Service at 1-800-815-6615 to inquire about the availability of these replacement parts.

Part #	Description
ADPT30	Power Adapter
30-00170	Load Cell Cable
B3822801-0	Battery Door Cover
10-00252	Battery Holder
B401338	Stretcher
C-HLA-J	Hoyer Jack Assembly

CALIBRATION









This scale has been factory calibrated, and does not require calibration prior to use. There are no requirements for calibration in the field; users should adhere to their institution's calibration policies.

Calibration of your scale can be performed using calibrated kilogram (kg) or pound (lb) weight standards. Minimum calibration is 200 lb / 100 kg. Maximum calibration weight is 400 lb / 181 kg. The required calibration standard will be the Unit of Measure (UOM) for which the scale is configured. **KG models can only be calibrated in kilograms.** If Everlock® is activated the scale can only be calibrated in the locked unit of measure.

Note: Only weights certified and traceable to national standards should be used for calibration.

Warning: Always ensure that the scale is returned to the correct UOM after scale calibration.

Note: Ensure the stretcher is attached to the scale before beginning the calibration procedure.

1. Press  to access the Help menu options.
2. While in the Help menu, press  to select "Calibrate". Press  to advance to the next step.
3. The display will prompt for entry of the password. Press the following keys in this sequence to proceed with the calibration procedure.    
4. The display will show a warning. If prepared and qualified to perform the calibration procedure, press  to advance to the next step.
5. Follow the screen prompt and ensure the scale is on a level surface with no weight on the stretcher. Press  to advance to the next step.
6. The display will show "Zeroing Scale" as it calculates the zero value. Do not touch the scale during the zeroing process.

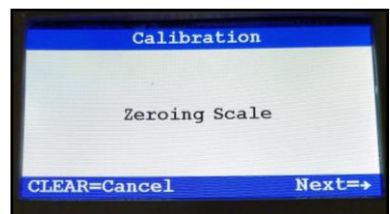
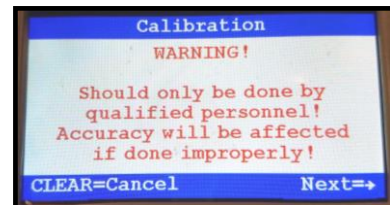
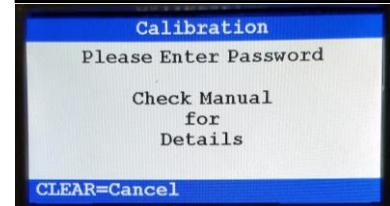
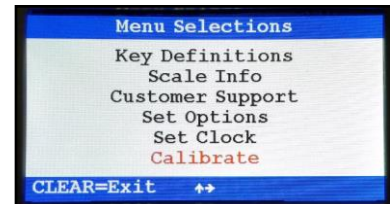

CALIBRATION (CONT)

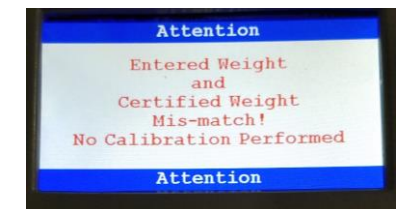
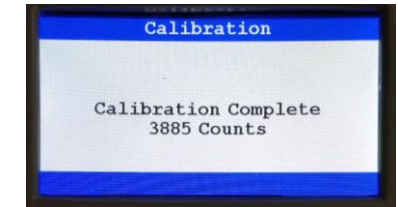
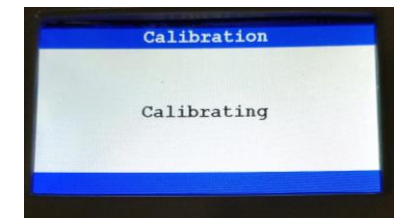
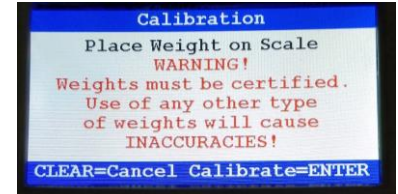

7. When the zeroing process is complete the display will prompt for entry of the calibration weight. Minimum calibration is 200 lb / 100 kg. Maximum calibration weight is 400 lb / 181 kg. Calibration weight can be adjusted in 10 lb or 10 kg increments. Press **Enter** when the calibration weight is set.
8. The display will prompt for the calibration weights to be placed on the stretcher. Press **Enter** after calibration weights are placed on the stretcher.
9. The display will show “Calibrating” during the calibration process.
10. If calibration is successful, the display will show “Calibration Complete” with a 4 digit calibration count.
11. If calibration is unsuccessful, the display will show an error message that the entered calibration weight and the certified weights do not match. The display will then revert back to the set calibration weight screen for entry of calibration weight.



TROUBLESHOOTING

Troubleshooting

Before contacting service personnel, refer to the following instructions to check and to correct any failures. For further assistance, contact Health o meter® Professional Scales Technical Support at 1-800-638-3722.

Symptom	Possible Cause	Corrective Action
Scale does not power on	<ol style="list-style-type: none"> 1. Dead Battery 2. Faulty electrical outlet 3. Bad power supply 	<ol style="list-style-type: none"> 1. Replace batteries 2. Use a different outlet 3. Replace AC adapter
Questionable weight or the scale does not zero	<ol style="list-style-type: none"> 1. External object interfering with the scale 2. The display did not show "0.0" before weighing 3. Scale is not placed on a level floor 4. Scale is out of calibration 	<ol style="list-style-type: none"> 1. Remove interfering object from the scale 2. Remove the patient from the stretcher, press  to zero the scale and begin weighing process again 3. Place the scale on a level floor. 4. Check weight with known weight value
Weighing is performed but the weighing process takes too long and the weight does not lock on the display	The stretcher is not still	Stabilize the stretcher so it is not moving
The battery icon on the display indicates that the batteries are low	The batteries are depleted	Replace batteries according to instructions on page 13
Scale is displaying "Load Cell Cable Not Detected"	The load cell cable is not completely plugged into the port	Inspect the load cell cable to ensure it is completely plugged into the port on the back of the display head. See page 10. If cable was plugged in, unplug and plug in again until it clicks into place.
In the Help menu, display is not advancing to the next screen for the menu selection and saying "invalid key"	Correct key is not being pressed	To make a selection in the Help Menu and advance the screen, press 

WARRANTY

Limited Warranty

What does the Warranty Cover?

This Health o meter® Professional scale is warranted from date of purchase against defects of materials or in workmanship for a period of two (2) years. If product fails to function properly, return the product, freight prepaid and properly packed to Pelstar, LLC (see "To Get Warranty Service", below, for instructions). If the manufacturer determines that a defect of material or in workmanship exists, the customer's sole remedy will be replacement of the scale at no charge. Replacement will be made with a new or remanufactured product or component. If the product is no longer available, replacement may be made with a similar product of equal or greater value. All replaced parts are covered only for the original warranty period.

Who is Covered?

The original purchaser of the product must have proof of purchase to receive warranty service. Please save your invoice or receipt. Pelstar dealers or retail stores selling Pelstar products do not have the right to alter, or modify or any way change the terms and conditions of this warranty.

What is Excluded?

Your warranty does not cover normal wear of parts or damage resulting from any of the following: negligent use or misuse of the product, use on improper voltage or current, use contrary to the operating instructions, abuse including tampering, damage in transit, or unauthorized repair or alternations. Further, the warranty does not cover natural disasters, such as fire, flood, hurricanes and tornadoes. This warranty gives you specific legal rights, and you may also have other rights that vary from country to country, state to state, province to province or jurisdiction to jurisdiction.

To get Warranty Service make sure you keep your sales receipt or document showing proof of purchase. Call (+1) 800-638-3722 or (+1) 708-377-0600 to receive a return authorization (RA) number, which must be included on the return label. Attach your proof of purchase to your defective product along with your name, address, daytime telephone number and description of the problem. Carefully package the product and send with shipping and insurance prepaid to:

Pelstar, LLC

Attention R/A# _____

Return Department

9500 West 55th Street

McCook, IL 60525

Extended Warranty Available*

This product is eligible for Health o meter® Professional ScaleSurance Extended Warranty Program. ScaleSurance extends the warranty period for an additional two years. This extension to the standard Limited Warranty can be purchased with new products or for a facility's existing product before its current warranty has expired. To learn more, visit www.homscales.com/scalesurance/ or contact your medical supply distributor.

*Not available in all countries.



PELSTAR, LLC

9500 West 55th St. McCook, IL 60525-7110 USA

1-800-638-3722 or 1-708-377-0600

PLEASE REGISTER YOUR SCALE FOR WARRANTY COVERAGE AT:

www.homscales.com

Health o meter® is a registered trademark of Sunbeam Products, Inc. used under license.

Health o meter® Professional products are manufactured, designed, and owned by Pelstar, LLC.

We reserve the right to improve, enhance, or modify Health o meter® Professional product features or specifications without notice.

© Pelstar, LLC 2019