



MLM

**Mechanical Infant Stadiometer
User Manual**



CARDINAL SCALE MFG. CO.

8525-M327-O1 Rev A
03/12

PO BOX 151 • WEBB CITY, MO 64870
PH (417) 673-4631 • FAX (417) 673-5001

www.detectoscale.com

Technical Support: Ph: 866-254-8261 • techsupport@cardet.com

Thank you for purchasing the Detecto MLM Mechanical Infant Stadiometer. All features of this product were designed for simple and easy use. If you have any questions or experience any problems not addressed in these operating instructions, please contact your Detecto Distributor, or contact Detecto Support.

Specifications

Model	MLM
Measuring Range	65mm – 1000mm / 2.5 – 39 inches
Graduation	1mm / 0.125 inch
Accuracy	±1mm / ± 0.125 inch



Safety Precautions

- Observe all operating instructions.
- Use only the supplied fixtures for mounting.
- Ensure all screws are tightened and that the device is assembled correctly.
- To prevent risk of injury, fold-in the head stop after each use.
- Never leave a baby on the surface unattended
- When sliding the measuring rod, ensure that baby is safely on the measuring area.
- **Do Not** modify this measuring device. This may result in incorrect measuring results, safety-related defects and/or device malfunction.

Maintenance

The device does not require any routine maintenance.

Daily cleaning with disinfectant is recommended.

Use

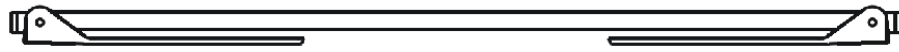

Place MLM on stable surface.

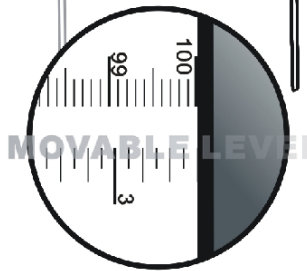
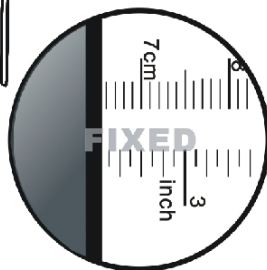
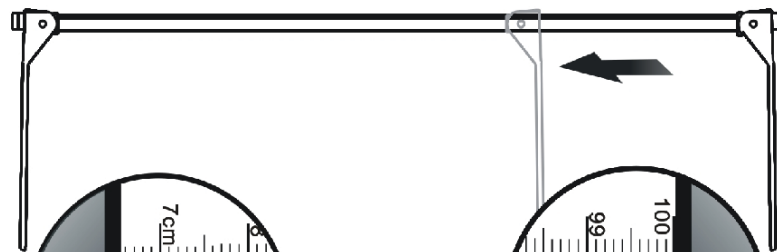
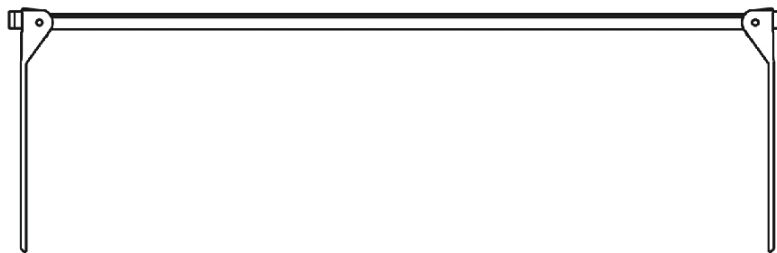
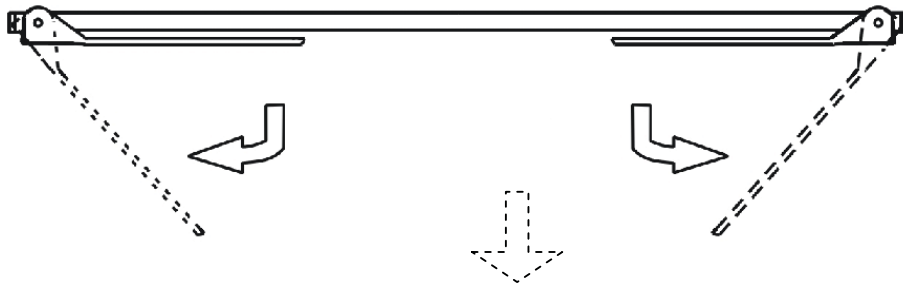

Measurement range is from 65mm to 1000mm / 2.5 – 39 inches
Slide foot-stop to measure the length of baby.

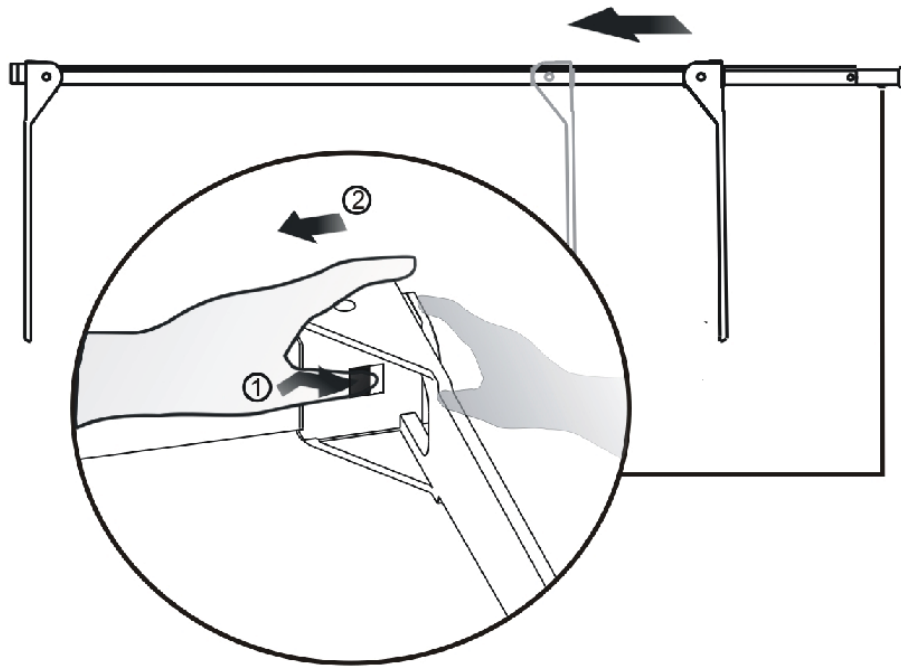

Push in the snap-lock to release foot-stop with your left hand.
Using your right hand to push foot-stop in the direction of baby's feet.

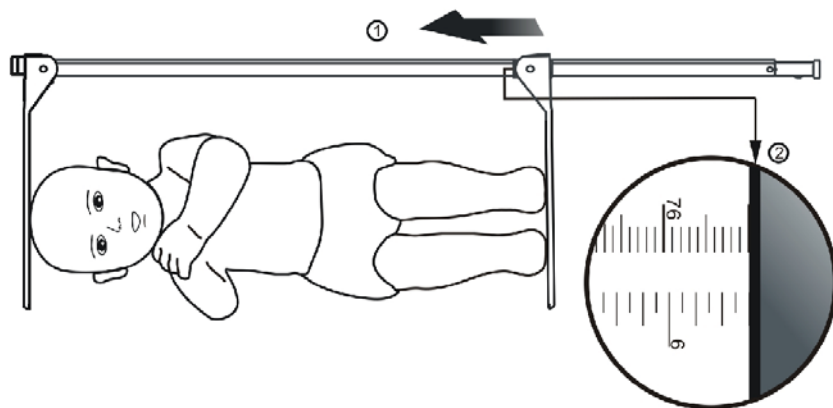

Keep the baby on the surface with the left hand gently.
Gently press baby's knees down.
Push foot-stop to the sole of the baby's feet and record baby's length.