

### **HIGHLAND SERIES**

(P.N. 9520, Revision E, October 2011)

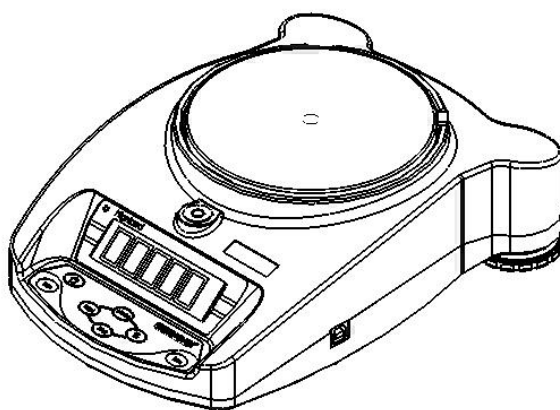

**Easy Reference:**

Model name of the scale:	
Serial number of the unit:	
Software revision number (Displayed when power is first turned on):	
Date of Purchase:	
Name of the supplier and place:	

## 1.0 CONTENTS

1.0	CONTENTS.....	1
2.0	INTRODUCTION.....	3
3.0	SET UP .....	3
3.1	UNPACKING AND SETTING UP YOUR BALANCE.....	3
3.2	DISPLAY / KEYBOARD FUNCTION .....	4
3.3	INTERNAL RECHARGEABLE BATTERY .....	5
3.4	LOCATING AND PROTECTING YOUR BALANCE.....	6
3.5	STORING WHEN NOT IN USE .....	7
4.0	BASIC OPERATION.....	8
4.1	TURNING ON THE BALANCE .....	8
4.2	ZEROING / TARE.....	8
4.4	WEIGHING.....	9
4.5	WEIGHING UNITS .....	9
5.0	FUNCTIONS .....	10
5.1	PERCENTAGE WEIGHING .....	10
5.2	PARTS COUNTING .....	10
5.3	ACCUMULATION.....	11
6.0	PARAMETERS.....	13
6.1	ENABLING WEIGHING UNITS .....	13
6.2	SETTING THE BACKLIGHT.....	14
6.3	SETTING THE PRINTING PARAMETERS / ACCUMULATION .....	15
6.4	AUTO POWER OFF .....	17
6.5	SELECTING THE INTERNAL OR EXTERNAL CALIBRATION .....	17
6.6	ADJUST THE VALUE OF THE INTERNAL MASS .....	18
6.7	SETTING USER PARAMETERS.....	19
7.0	CALIBRATION.....	20
8.0	TROUBLE SHOOTING.....	22
8.1	ERROR MESSAGES .....	22
8.2	REPLACEMENT PARTS AND ACCESSORIES.....	23
9.0	SPECIFICATIONS.....	24
9.1	TECHNICAL SPECIFICATIONS.....	24
9.2	COMMON SPECIFICATIONS .....	24
9.3	RS-232 / USB SPECIFICATIONS .....	24
10.0	CALIBRATION CERTIFICATE .....	28
11.0	WARRANTY STATEMENT.....	28



## 2.0 INTRODUCTION

Thank you for purchasing your new **Highland™** portable balance, Every **Highland™** balance has all the features you really need: AC adapter and internal rechargeable battery, **HandiCal™** calibration, backlit display, and **ShockProtect™** with overload indicator. With RS-232 and USB interface for communication with printers and computers, splash-proof keypad, and sturdy plastic construction, the **Highland™** series will be a balance you can rely upon. We hope that you enjoy using your new balance.

## 3.0 SET UP

### 3.1 UNPACKING AND SETTING UP YOUR BALANCE

- 1) Remove the balance, draft shield, top pan, AC adapter and pan support from the packaging
- 2) Remove the shipping protection screw and transit disc from the top of the balance and place the plastic top pan support on the balance. Do not use excessive force when removing and installing the screw.

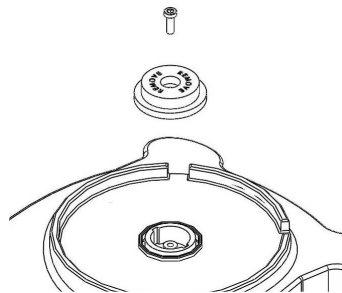

- 3) Gently place the plastic pan support into the receptacle and secure with the supplied screw. Do not over-tighten the screw. It should be finger tight only. Put the Stainless steel pan on top of the pan support
- 4) Place the draft shield on top of the balance, the location notches in the breeze shield should align with the cut outs on the balance. For optimum performance the balance should be used with the draft shield (if provided).

### 3.2 DISPLAY / KEYBOARD FUNCTION

The display and keypad have a number of features the key information is shown below:

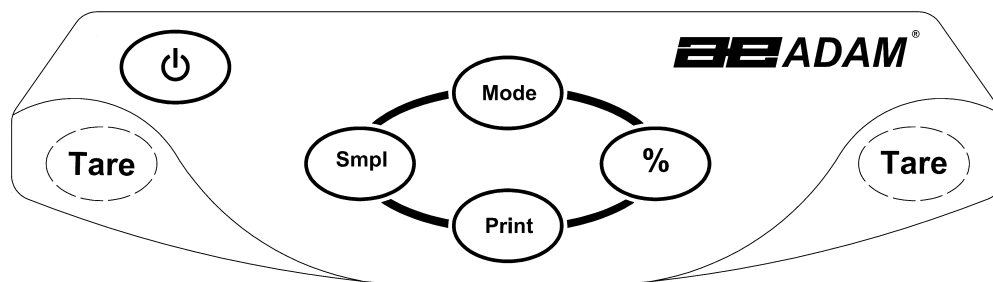

KEYS	PRIMARY FUNCTION	SECONDARY FUNCTION
[On/Off]	To turn the balance On or Off.	----
[Tare]	Tares the balance and shows the net weight value. Pressing the [Tare] again will reset another tare value	A secondary function of "Enter" key is for setting parameters or other functions.
[%]	Enters the percentage weighing function.	When in percentage mode, press [%] key to return to normal weighing mode. When setting some parameters this key will move the flashing digit to the right.
[Smpl]	Use this key to enter parts counting mode from the normal weighing mode.	When in parts counting pressing the [Smpl] will return to weighing mode. Clears the accumulated value from the memory when pressed during the total. When setting some parameters this key will move the flashing digit to the left.
[Mode]	Pressing this key will cycle through the weighing units which are enabled.	Displays the unit weight, total weight and the count when in the parts counting mode. Setting parameters it will show the next option or increase the value of a flashing digit.
[Print]	To print the results to a PC or printer using RS-232 or USB interface. It also adds the value to the accumulated memory if the accumulation function is not automatic.	Secondary function is to return to normal operation when the balance is in a parameter setting mode. Setting parameters it will show the previous option or decrease the value of a flashing digit.

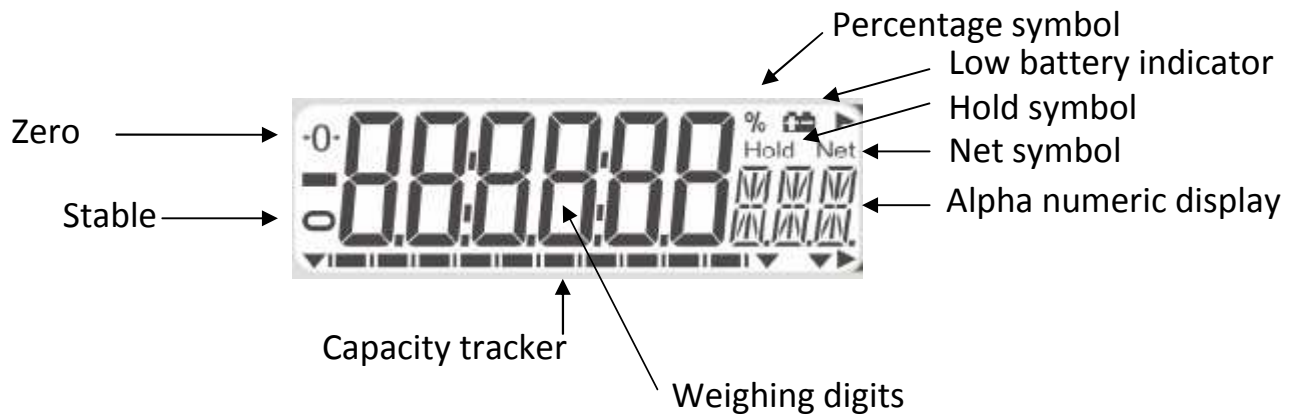

### 3.3 INTERNAL RECHARGEABLE BATTERY

The balance can be operated from the internal rechargeable battery or using an AC adapter. The battery discharge time, is approximately 24 hours depending on the usage of the backlight.

The display will show an indication when the battery needs to be charged. To charge the battery, plug in the AC adapter at the back of the balance and attach it to the main power supply. The charging indicator at the left top corner of the LCD will be on.

### 3.4 LOCATING AND PROTECTING YOUR BALANCE

In order to keep your balance functioning at its best we suggest that you do the following:



Avoid extremes of temperature. Do not place in direct sunlight or near air conditioning vents.



Make sure the balance is located on a strong table and free from vibration.

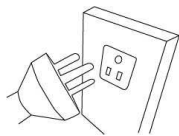

Avoid unstable power sources. Do not use near large users of electricity such as welding equipment or large motors. Do not let the balance battery go flat – if you are not using it for a long time you should charge the battery up periodically to make sure the battery does not lose its charge.

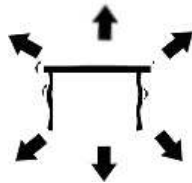

Keep free from vibration. Do not place near heavy or vibrating machinery.



Avoid high humidity that might cause condensation. Keep away from direct contact with water. Do not spray or immerse the balance in water.

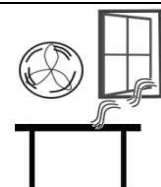

Do not place near open windows, air-conditioning vents or fans that may cause a draft and unstable readings.

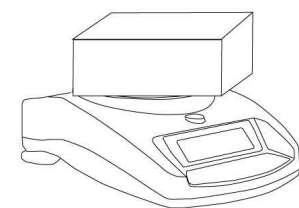

Keep the balance clean. Do not stack material on the balance / balance pan when it is not in use. The Highland has a stacking feature for stacking more than one unit on top of each other which does not apply weight to the pan. For more details on this see the section on storing.



### 3.5 STORING WHEN NOT IN USE

If you have any of the **Highland™** series or **Core Balance™** lines you can store them easily on top of each other. To save space and protect them from damage.

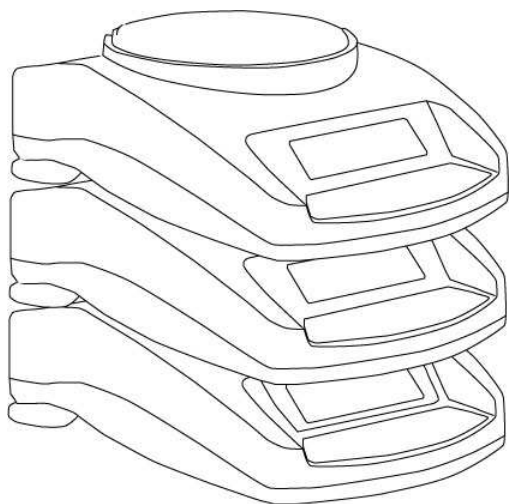

*Without Shield*

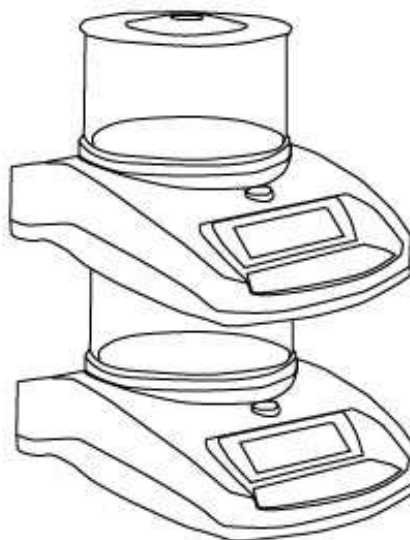

*With Shield*

**Note:** Only models equipped with a  $\varnothing$  4.7" / 120mm pan, can be stacked for storage. Core models with the larger  $\varnothing$  5.7" / 145mm may be stacked at the top of the pile but other balances should NOT be stacked on top of them due to the larger pan size.

## 4.0 BASIC OPERATION

### 4.1 TURNING ON THE BALANCE

Plug in the unit using the AC adapter or use the internal rechargeable battery. It is recommended that you charge the battery for at least 8 hours before first use.

- 1) To turn on press the **[on/off]** key once and release. The balance will show the software revision and the capacity then self-test before showing zero on the display and the stable sign.
- 2) The balance is ready to be used.
- 3) To turn the balance off after use press the **[on/off]** key again. There is an auto power-off function that will automatically turn the unit off if not used for a period of time, this can be set in the parameters section.

If an error is shown while turning on the balance check the internal calibration weight has not been left in the calibrate position. Move the lever all the way to the left. Turn off the balance and turn it back on again.

### 4.2 ZEROING / TARE

You can press the **[Tare]** key to set a new zero point and show the zero reading if the weight reading is less than 4% of the total of the maximum capacity of the balance. This may be necessary if the weight reading is not reading zero with nothing on the pan. The zero indicator will show up in the upper left corner of the LCD.

If you are using a container to weigh then you can place this on the platform and press the **[Tare]** key. Providing the container weight is more than 4% of the maximum capacity of the balance, the digits will show zero and **NET** will light up on the display. You can then weigh your sample in the container. Taring weight subtracts from the total balance capacity.



**Note:** When the container is removed a negative value will be shown equivalent to the total value of the amount tared. The balance will not tare a value for a container unless the stability light indicates that the weight is stable thus ensuring a correct taring function.

#### **4.4 WEIGHING**

To determine the weight of a sample, first tare an empty container (if used), then place the sample in the container. The display will show the weight of the sample and the unit of weight currently in use. The stable indicator will light when the reading is stable.

#### **4.5 WEIGHING UNITS**

To change the weighing units, press **[Mode]** to cycle through the options of units that are enabled. See Parameters 6.1 *Enabling Weighing Units*, to enable or disable the weighing units.

## 5.0 FUNCTIONS

### 5.1 PERCENTAGE WEIGHING

The balance will allow a reference weight to be shown as 100%. Then any other weight placed on the balance will be displayed as a percentage of the original sample.

- 1) Place your weight on the balance.
- 2) Press the [%] key. The weight will be displayed as 100.00%.
- 3) Remove the weight and place your next sample on the balance. The new reading will be shown as a percentage of the first value / reference used.
- 4) Pressing the [%] key again will return the balance to normal weighing.

**Note:** The balance may jump by large numbers unexpectedly if small weights are used to set the 100% level. For example, if only 23.5g is on a balance with 0.5g increments and the balance is set to 100%, the display will show 100.00%. However, a small change of weight will cause the display to jump to 102.13%, as one balance division (0.5g) increase to 24.0g will be equivalent to a 2.13% increase.

### 5.2 PARTS COUNTING

Parts counting lets you count small parts that are of equal weight, quickly and easily. To do this you must first set your sample by telling the balance how many parts you have.

- 1) Place your container on the balance and press the **[Tare]** key as described in 4.2 *Zeroing / Tare* section. This will remove the weight of the container from your count.
- 2) When the balance is in normal weighing mode with the initial quantity on the balance, press the **[Smpl]** key to start the parts counting function.
- 3) The initial number of samples should match the options for parts counting, 10, 20, 50, 100 or 200 pieces.
- 4) The balance will initially show **SP 10** asking for a sample size of 10 parts. Press **[Mode]** to cycle through the options: 10, 20, 50, 100, 200 and back to 10 to select the sample you have placed on the balance.

- 5) Press **[Smpl]** again once you have selected the sample. The display will show you the number. As more parts are added the display will show the total number of parts (**PCS** – will be shown in the alpha-numeric display).
- 6) By pressing the **[Mode]** key you can view the unit weight (**W/P**), total weight (**g**) or the count (**PCS**). The total and the unit weight are shown in the current weighing units.
- 7) Press **[Smpl]** to return to normal weighing.

### 5.3 ACCUMULATION

There are two types of accumulations – automatic and manual.

<b>Automatic Accumulation</b>	<b>Manual Accumulation</b>
When the balance is set for automatic accumulation, see Parameters 6.3 <i>Setting the Printer Parameters / Accumulation</i> , the weight will be added to the memory when the balance becomes stable.	When the balance is set to manual accumulation, see Parameters 6.3 <i>Setting the Printer Parameters / Accumulation</i> , the weight displayed will only be stored in memory once the <b>[Print]</b> key is pressed and the weight is stable.

- 1) Place the weight on the balance. If automatic then the balance will automatically accumulate the weight. If set to manual then you will need to press the **[Print]** key.
- 2) The display will show **ACC 1** followed by the total value in the memory for 2 seconds before returning to displaying the weight of the item on the balance.
- 3) The weight will be transmitted to a printer or PC.
- 4) Remove the weight, allowing the balance to return to zero.
- 5) Put a second weight on. Again if set to automatic it will accumulate the weight automatically. Alternatively press **[Print]**, the display will show **ACC 2** followed by the new total in the memory for 2 seconds before returning to displaying the weight of the item on the balance.
- 6) Continue until all weights have been added.

To view the totals in memory press the **[Print]** key when the balance is at zero. The display will show **ACC xx** (where “xx” is the total number of readings) and the total weight, before returning to zero. At the same time the total will also be sent via the RS-232 interface.

To clear the memory, press **[Smpl]** once the total accumulation value is displayed, after the pressing **[Print]**.

## 6.0 PARAMETERS

The balance has 7 parameters that can be set by the user.

FUNCTION	SECTION	DESCRIPTION
<b>F1 UNT</b>	See section 6.1	Sets the units to be used g / ct / Lb / oz / d / GN / OZt / dWt / MM / TL.T / TL.C / TL.t / t / N /g2.
<b>F2 EL</b>	See section 6.2	Sets the backlight EL on: backlight always on EL AU: backlight automatically turns on when a key is pressed EL OFF: backlight always off
<b>F3 SEr</b>	See section 6.3	Sets the print parameters
<b>F4 oFF</b>	See section 6.4	Sets the auto power-off parameter
<b>F5 IEC</b>	See section 6.5	Internal or external calibration select
<b>F6 CA</b>	See section 6.6	Cal mass fine adjust
<b>F7 SEt</b>	See section 6.7	User Parameters for autozero, filter and stability
<b>TECH</b>		Technical parameters setting mode / factory setting

### 6.1 ENABLING WEIGHING UNITS

You can enable and disable the weighing units available to the user when they press the **[Mode]** key as described in section 4.5 *Weighing Units*.

- 1) To set this parameter press and hold the **[Mode]** key during self-checking test when turning on the balance.
- 2) After a few seconds, the display will show the first function **F1 UNT**.
- 3) Press the **[Tare]** key to view the current settings of each unit.
- 4) Pressing the **[Tare]** key will cycle through the other units along with their current settings. For example, if **oFF** is displayed with the weighing unit Carats, the user will not be able to use this unit while weighing.
- 5) Pressing the **[Mode]** key will change the setting of a particular unit. For example, to enable the weighing unit Carats, change the setting to **oN** by pressing the **[Mode]** key.

- 6) When **F1 Unt** is displayed, you can press the **[Print]** key to return to weighing or press **[Mode]** to go to the next function.

The following table shows different units which are available to the user and the conversion factors for each.

<b>Name of the Units</b>	<b>Description</b>	<b>Conversion Factor</b>	<b>Display Symbol</b>
Grams	A standard metric unit	1.0	g
Carats	Used for weighing jewelry and gems, etc.	5.0	ct
Pounds	Standard weighing unit in UK/USA. *	0.0022046	Lb
Ounce	Avoirdupois ounce. 16 ounces make a pound.	0.035274	oZ
Drams	An ancient unit of weight. Equal to 1/16 <sup>th</sup> of an ounce.	0.564383	d
Grains	A basic weighing unit in the imperial system. Used to weigh gun powder.	15.43236	GN
Ounce Troy	Troy ounce- used for weighing gold, silver and in pharmacy.	0.03215075	oZt
Pennyweight	Pennyweight was the weight of a silver penny in medieval England. Equals to 1/20 <sup>th</sup> of an Ounce Troy.	0.6430149	dwt
Mommes	A weighing unit used in Japan to weigh pearls.	0.266667	MM
Taels Hk.	Hongkong Taels- used to weigh coral, pearls, etc.	0.026717	TL.H
Taels C.	China (Singapore)Taels	0.026455	TL.C
Taels t.	Taiwan Taels	0.026667	TL.t
Tola	An Asian weighing unit	0.085735	t
Newtons	Used to measure force	0.009807	N
Grams	Grams with last digit suppressed	1.0	g2
Tales J.	Japan Taels	0.026717	TL.J
* Lbs are not available on HCB123 Model			

## **6.2 SETTING THE BACKLIGHT**

The backlight may be enabled or disabled by the user. If the backlight is disabled, the battery life will be greater. The following settings are available:

<b>EL AU</b>	Sets the backlight to operate automatically when a weight is placed on the balance or a key is pressed.
<b>EL Off</b>	Sets the backlight to be off.
<b>EL On</b>	Sets the backlight to be on for full time.



- 1) To set this parameter press the **[Mode]** key during self-checking test when turning on the balance.
- 2) After a few seconds, the display will show the first function **F1 UNT**.
- 3) Press the **[Mode]** key to select **F2 EL**.
- 4) Press the **[Tare]** key to view the current settings for the backlight.
- 5) To change the settings press the **[Mode]** key to scroll through other settings as shown above.
- 6) Press **[Tare]** to store a particular setting. The display will return to **F2 EL**
- 7) When **F2 EL** is displayed press the **[Print]** key to return to weighing or press **[Mode]** to go to the next function.

### 6.3 SETTING THE PRINTING PARAMETERS / ACCUMULATION

- 1) To set this parameter press the **[Mode]** key during self-checking test when turning on the balance.
- 2) After a few seconds, the display will show the first function **F1 UNT**.
- 3) Keep pressing the **[Mode]** key until **F3 SEr** is displayed.
- 4) Press the **[Tare]** key to view the current settings.
- 5) First select which communication port you wish to configure and set (only one port can be used at a time).

The screen will show **S 232** or **S USB**. Press the **[Mode]** key to select which interface you would like to use. Press **[Tare]** to confirm setting and configure interface.

- 6) The following options are available for setting the output and accumulation functions:

Mode	Print Feature	Accumulation
<b>P1 Prt</b>	Data is sent whenever the <b>[Print]</b> key is pressed.	Manual accumulation when the <b>[Print]</b> key is pressed.
<b>P2 Con</b>	Data is sent continuously.	Accumulation is disabled.

<b>P3 AUT</b>	The weighing results will be sent to the communication port automatically whenever a stable reading is present. The balance has to return to zero before another reading is sent via the interface.	Automatic accumulation when stable
---------------	---	------------------------------------

Press the **[Mode]** key to change the setting. Press **[Tare]** to confirm and move to the next parameter.

- 7) Setting the baud rate. This is the transmission speed for communication with printers and computers. The selected rate must match that of the other device for communications to work.

The following settings are available:

<b>b 600</b>
<b>b 1200</b>
<b>b 2400</b>
<b>b 4800</b>
<b>b 9600</b>

Press the **[Mode]** key to change the setting. Press **[Tare]** to confirm and move to the next parameter.

- 8) Parity settings. Parity is a communications check. There are 3 settings that the Highland can work with as follows:

<b>8 n 1</b>	8 data bits, no parity
<b>7 E 1</b>	7 data bits, even parity
<b>7 O 1</b>	7 data bits, odd parity

Press the **[Mode]** key to change the setting. Press **[Tare]** to confirm and move to the next parameter.

- 9) Format settings. The scale will print either using a format that includes stability indications or one with only the weight. There are 2 settings that the Highland can work with as follows:

<b>F0r 1</b>	Data format is with line headings and extra line feeds as shown in section 9.3
<b>F0r 2</b>	Data format is weight only

Press the [**Mode**] key to change the setting. Press [**Tare**] to confirm and move to the next parameter.

- 10) The display will go back showing F3 SEr. Press the [Print] key to return to weighing or press [**Mode**] to go to the next function.

#### **6.4 AUTO POWER OFF**

The auto power off function helps conserve power, when using the internal rechargeable battery or AC adapter. The Auto switch-off time may be set up by the user.

- 1) To set this parameter press the [**Mode**] key during self-checking test when turning on the balance.
- 2) After a few seconds, the display will show the first function **F1 UNT**.
- 3) Keep pressing the [**Mode**] key until **F4 OFF** is displayed.
- 4) Press the [**Tare**] key to view the current settings.
- 5) Press [**Mode**] to change the settings (0, 5, 10, 20 and 30 minutes).
- 6) Press [**Tare**] to store a particular setting. The display will return to **F4 OFF**
- 7) When **F4 OFF** is displayed press the [Print] key to return to weighing or press [**Mode**] to go to the next function.

#### **6.5 SELECTING THE INTERNAL OR EXTERNAL CALIBRATION**

You can select if the internal mass or an external mass is to be used to calibrate the balance.

- 1) To set this parameter press the **[Mode]** key during self-checking test when turning on the balance.
- 2) After a few seconds, the display will show the first function **F1 UNT**.
- 3) Keep pressing the **[Mode]** key until **F5 IEC** is displayed.
- 4) Press the **[Tare]** key to view the current settings.
- 5) To change the settings press the **[Mode]** key to change from **Int** (internal calibration) or **E** (external calibration)
- 6) Press **[Tare]** to store a particular setting. The display will return to **F5 IEC**
- 7) When **F5 IEC** is displayed press the **[Print]** key to return to weighing or press **[Mode]** to go to the next function.

## **6.6 ADJUST THE VALUE OF THE INTERNAL MASS**

The internal mass value stored in memory can be adjusted to more closely match the value of the user's external mass.

- 1) To set this parameter press the **[Mode]** key during self-checking test when turning on the balance.
- 2) After a few seconds, the display will show the first function **F1 UNT**.
- 3) Keep pressing the **[Mode]** key until **F6 CA** is displayed.
- 4) Press the **[Tare]** key to view the current settings.
- 5) The display will show the current value with the first digit flashing. To change the value press **[%]** to shift the position, press **[Mode]** to increase the value and press **[Print]** to decrease the value. The internal calibration weight should only change between **95.000** and **105.000** grams or **495.00** and **505.00** grams (depending upon the model).
- 6) Press **[Tare]** to store a particular setting. The display will return to **F6 CA**
- 7) When **F6 CA** is displayed press the **[Print]** key to return to weighing or press **[Mode]** to go to the next function.



Changing the value of the internal weight will affect the calibration when using the internal calibration. To check if your internal weight is correct you should only use high quality weights that are accurate to the readability of the balance.

## 6.7 SETTING USER PARAMETERS

The balance has a number of parameters the user can adjust.

Display	Description	Default Value
n FIL	Filter settings, 1, 2 or 3 1 is the fastest filter, 3 is the slowest.	1 FIL
n ZEO	The Automatic Rezero range 0 to 8, 0 being with auto zero off, and 8 is the zero range of 4 divisions.	4 ZEO
n STA	Stability symbol range, 0 to 5 0 is the smallest stability range and 5 is largest.	2 STA
n ZTR	Weight Tracking Range, 0 to 5	3 ZTR

Press the **[Tare]** key to view the current settings.

To change the settings press the **[Mode]** key. Press the **[Tare]** key to advance to the next parameter. When completed the display will show **F7 SET** again.

Pressing **[Mode]** will then show **TECH**. This function is a manufacturing function for qualified technicians only and you can press **[Mode]** again to scroll through parameter options, or press **[Print]** to return to normal weighing.

## 7.0 CALIBRATION

The **Highland** series of balances comes standard with **HandiCal™** internal calibration to make calibrating the balance quick and easy. However you can also calibrate the balance using an external verification weight if needed. The **HandiCal** method is the default but if you would like to use external calibration then you must first enable this via the parameter (section 6.5 *Selecting The Internal Or External Calibration*).

Install the handle for the calibration as shown below. To calibrate the handle is pushed to the side to lower the calibration mass.

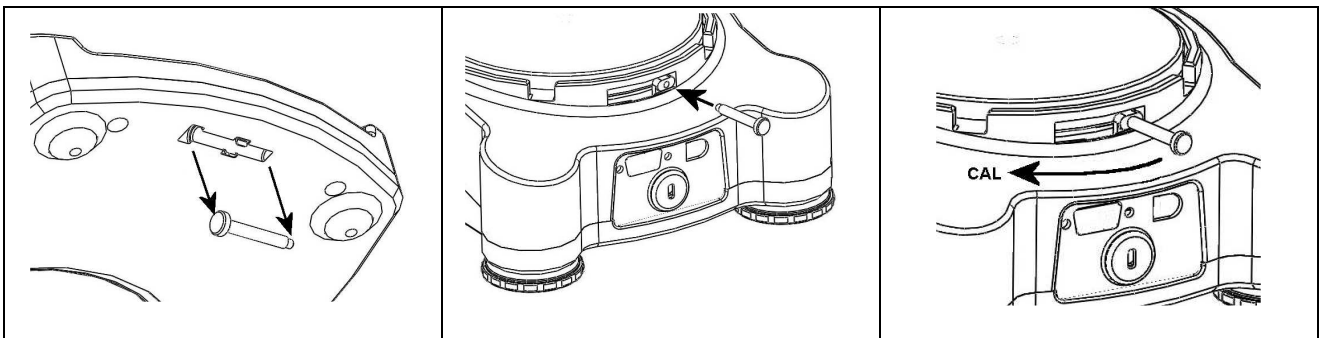

### ***Internal Calibration using HandiCal***

- 1) Press the **[on/off]** key to turn the power on.
- 2) Press the **[Smpl]** and **[Print]** keys at the same time during the self-checking test.
- 3) The display will show **unload**. Remove any weight from the stainless steel pan.
- 4) When the stable indicator shows press the **[Tare]** key.
- 5) The display shows **C Int**. Press the **[Tare]** key
- 6) The display shows **LoAd**. Lower the internal calibration mass located behind the pan. Use the handle to help lower the weight as far as it will go. Press the **[Tare]** key once the stable sign is shown.
- 7) The display will show **PASS**. Rotate the weight back to its off position. Once removed the balance will return to zero.

## External Calibration

- 1) Press the **[on/off]** key to turn the power on.
- 2) Press the **[Smpl]** and **[Print]** keys at the same time during the self-checking test.
- 3) The display will show **unload**. Remove any weight from the stainless steel pan.
- 4) When the stable indicator shows press the **[Tare]** key.
- 5) The display will show the first weight that you can use to calibrate the unit. You can change this value by pressing the **[Mode]** key. The weights that can be used are as follows:

Model #	HCB123	HCB153	HCB302	HCB602	HCB602H	HCB1002	HCB1502	HCB3001
Weight 1	60g	50g	100g	200g	200g	500g	500g	1000g
Weight 2	120g	100g	200g	400g	400g	1000g	1000g	2000g
Weight 3	-	150g	300g	600g	600g	-	1500g	3000g

- 6) Once the calibration weight has been selected press the **[Tare]** key
- 8) The display shows **LoAd**. Place your weight on the pan. Press **[Tare]** key once the stable sign is shown.
- 9) The display will show **PASS**. Remove the weight from the pan.

**NOTE:** If the calibration fails retry. The balance will show **FAIL H** (when the weight is higher) or **FAIL L** (when the weight is lower). Repeat the process using the correct calibration weight.

## 8.0 TROUBLE SHOOTING

### 8.1 ERROR MESSAGES

If an error message is shown, repeat the step that caused the message. If the error message is still shown then contact your dealer for support.

ERROR CODE	DESCRIPTION	POSSIBLE CAUSES	SOLUTIONS
<b>Err 4</b>	Initial Zero is greater than allowed (4% of maximum capacity) when power is turned on or when the <b>[Tare]</b> key is pressed.	Weight on the pan when turning on. Excessive weight on the pan when zeroing the balance. Improper calibration of the balance. Damaged load cell. Damaged Electronics.	Remove the transit screw make sure the pan is fitted correctly. Make sure the calibration weight is in its off position. Remove any weight from the stainless steel pan. Try recalibrating.
<b>Err 5</b>	Keyboard Error.	Improper operation of the balance.	Turn the balance off and back on again.
<b>Err 6</b>	A/D count is not correct when turning the scale on.	Load cell damaged. Electronics damaged.	Remove any weight from the stainless steel pan and turn the balance off and back on again. Try calibrating the balance.
<b>Err 9</b>	A/D count is not stable when turning the scale on.	Load cell damage. Something touching the pan. Air movement, vibration or instability.	There may be movement, vibration or dirt on scale during turning on. Make sure there is nothing touching the pan. Make sure the internal weight is in the off position. Make sure the balance is level. Try recalibrating.
	Low Battery indicator.	Internal battery may be flat.	Charge the battery or replace internal rechargeable battery.
	Unstable – balance cannot get a stable reading.	Possible damage to the mechanics / Loadcell.	Make sure the balance is on a flat surface and away from vibration. Make sure the calibration weight is in its off position.
Red Light on front panel	Low Battery indicator.	Internal battery may be flat.	Charge the battery or replace internal rechargeable battery.
	No Power when turning on.	Internal battery may be flat.	Charge the battery or replace internal rechargeable battery.



## 8.2 REPLACEMENT PARTS AND ACCESSORIES

If you need to order any spare parts and accessories, contact your supplier or Adam Equipment. A partial list of the more common items follows:

Part Number	Description
3.07.4.0.10266	RS-232 interface cable
3.07.4.0.10267	USB interface cable
7.00.1.0.0046	Security lock and cable
3.08.1.0.2043	Hard Carry case
7.00.0.0.0012	Thermal Printer
6.00.0.0.2028	AdamDU (Data Collection Software)
3.08.2.3.2030	In-use wet cover
3.02.4.0.9160	AC adapter USA plug 12VDC 800mA
3.02.4.0.9156	AC adapter UK plug 12VDC 800mA
3.02.4.0.9157	AC adapter Euro plug 12VDC 800mA
3.02.4.0.9158	AC adapter SA plug 12VDC 800mA
3.02.4.0.9159	AC adapter Australian plug 12VDC 800mA
3.08.1.2.2009	Stainless steel pan, 120mm
3.08.2.3.2008	Sub Pan 120mm
3.08.2.3.2024	Draft shield (includes lid)
3.08.1.2.2044	<b>HandiCal™</b> calibration handle
3.09.4.0.9012	Battery, 6V/1.3ah

## 9.0 SPECIFICATIONS

### 9.1 TECHNICAL SPECIFICATIONS

	HCB123	HCB153	HCB302	HCB602	HCB602H	HCB1002	HCB1502	HCB3001
Maximum Capacity	120g	150g	300g	600g	600g	1000g	1500g	3000g
Readability	0.001g	0.005g	0.01g	0.02g	0.01g	0.01 g	0.05g	0.1g
Repeatability(s.d.)	0.002g	0.005g	0.01g	0.02g	0.01g	0.01 g	0.05g	0.1g
Linearity $\pm$	0.003g	0.01g	0.02g	0.04g	0.03g	0.02 g	0.1g	0.2g
Pan	120mm / 4.7" $\phi$							
Draft shield	Included as standard							
Units of Measure	g / ct / Lb / oZ / d / GN / oZt / dWt / MM / TL.H / TL.C / TL.t / t / N /g2. / TL.J Lb. are not available on HCB123 Model							

### 9.2 COMMON SPECIFICATIONS

Interface	USB and RS-232, bi-directional
Stabilization Time	2 Seconds typical
Operating Temperature	0°C to 40°C / 32°F to 104°F
Power supply (external)	12VDC 800 mA
Calibration	HandiCal Internal calibration or external calibration - User selectable
Display	18mm high 6 digits LCD With auto backlight and loading bar graph
Scale Housing	ABS Plastic with Stainless Steel Pan
Overall Dimensions (wxdxh)	170 x 245 x 80mm / 6.7" x 9.6" X 3.1"
Net Weight	1.5 kg / 3.3 lb

### 9.3 RS-232 / USB SPECIFICATIONS

Either the RS-232 or USB interface can be used at one time. To avoid confusion when sending commands do not use both interfaces at the same time. See parameters *6.3 Setting The Printing Parameters / Accumulation* section for full information on settings

The standard Interface parameters are:

RS-232 output of weighing data ASCII code 4800 Baud 8 data bits No Parity
---

Connection details are:

RS-232 Connector: 9 pin d-subminiature socket
Pin 3 Output
Pin 2 Input
Pin 5 Signal Ground

Generally a Null model cable is required for connection to a computer or printers.

USB Connection is using a standard USB connector.

Software for using the USB interface with a PC is available from the Adam Equipment web site.

Data Format for normal weighing operations, parts counting or recalling of totals from memory will all be different. All lines end with a carriage return and a line feed, (0dH and 0aH in ASCII).

**Format 1 Output:**

The lines will include a heading for each line then the value. A typical output when weighing is shown below. 3 lines of data are printed followed by 2 blank lines.

G S _ _ _ _ _ 1 2 3 . 4 5 _ g _ <cr> <lf>	19 ASCII Characters, GS for Gross Weight, NT for Net Weight
N o . _ _ _ _ _ _ _ _ 0 1 <cr> <lf>	16 ASCII Characters, Increments every time a weight is stored in memory
T o t a l _ _ _ 1 2 3 . 4 5 _ g _ <cr> <lf>	19 Characters, The total weight stored in memory
<cr> <lf>	Includes 2 blank lines
<cr> <lf>	

When the scale is at zero the weight is not printed, only the number of items and total are printed.

If the scale is set for continuous output the weight only is printed followed by 2 blank lines. And example of continuous output is shown below.

G T , N T ± _ _ _ _ _ 1 2 3 . 4 5 _ g _ <cr> <lf>	Includes 2 blank lines
<cr> <lf>	
<cr> <lf>	
22 Characters, ST for stable/US for unstable followed by GS for Gross Weight/ NT for Net Weight and then a minus sign for negative weight, or a space for positive weight.	

## **Format 2 Output:**

The output will be the same value as is on the display. If parts counting it will be the count, if weighing it is only the weight.

An example output is :

```
± _ _ _ _ _ 1 2 3 . 4 5 _ g _ <cr> <lf>
```

Parts Counting example:

```
± _ _ _ _ _ 1 2 5 P C S <cr> <lf>
```

16 Characters, Begins with the sign, a minus sign for negative weight, or a space for positive weight.

For all examples if the weighing unit is one letter (i.e. grams=g) the 2<sup>nd</sup> of the units positions is used with a space before and after. If it is 2 letters long the 1st and second position is used with a space after the second letter, (i.e. 0.12345lb\_\_ ) or if it is 3 letters long all 3 positions are used, (i.e. 123.45dwt).

## **Input command format:**

The scale can be controlled with the following commands. The commands must be sent in upper case letters, i.e. "T" not "t".

<b>T&lt;cr&gt;&lt;lf&gt;</b>	Tares the scale to display the net weight. This is the same as pressing <b>[Tare]</b> key.
<b>Z&lt;cr&gt;&lt;lf&gt;</b>	Sets the zero point for all subsequent weighing. Display shows zero.
<b>T5.345&lt;cr&gt;&lt;lf&gt;</b>	Would be same as entering a preset tare value of 5.345 from keypad
<b>P&lt;cr&gt;&lt;lf&gt;</b>	Prints the results to a PC or printer using the optional RS-232 interface. It also adds the value to the accumulation memory if the accumulation function is not set to automatic.



## 10.0 CALIBRATION CERTIFICATE

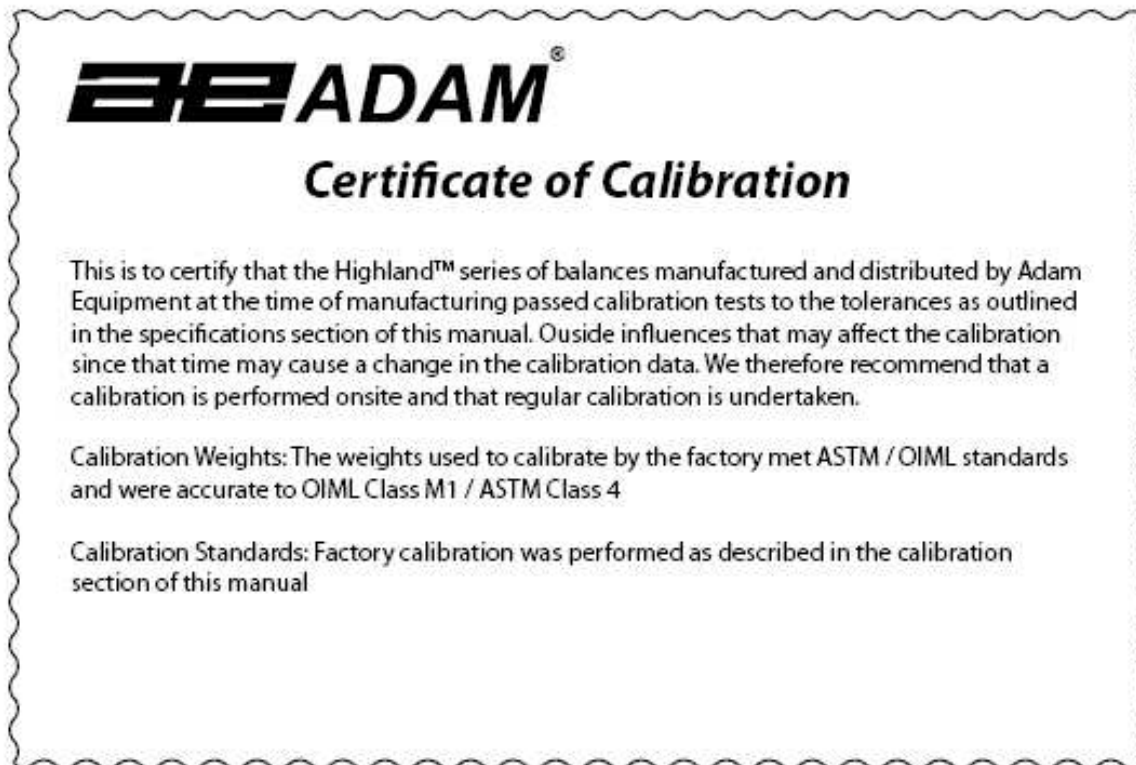

## 11.0 WARRANTY STATEMENT

Adam Equipment offers Limited Warranty (Parts and Labor) for the components failed due to defects in materials or workmanship. Warranty starts from the date of delivery.

During the warranty period, should any repairs be necessary, the customer must inform the supplier or Adam Equipment. The company or its authorised Technician reserves the right to repair or replace any components at its own discretion. Any shipping costs involved in sending the faulty units to a service centre is the customers responsibility.

The warranty will cease to operate if the equipment is not returned in the original packaging and with correct documentation for a claim to be processed. All claims are at the sole discretion of Adam Equipment.

This warranty does not cover equipment where defects or poor performance is due to misuse, accidental damage, exposure to radioactive or corrosive materials, negligence, faulty installation, unauthorised modifications or attempted repair or failure to observe the requirements and recommendations as given in this User Manual.

Repairs carried out under the warranty does not extend the warranty period. Components removed during the warranty repairs become the company property of Adam Equipment.

The statutory right of the purchaser is not affected by this warranty. The terms of this warranty are governed by the Laws of England and Wales. For complete details on Warranty Information, see the terms and conditions of sale available on our web-site.

### Manufacturer's Declaration of Conformity

This product has been manufactured in accordance with the harmonised European standards, following the provisions of the below stated directives:

Electro Magnetic Compatibility Directive 2004/108/EC

Low Voltage Directive 2006/95/EC

Adam Equipment Co. Ltd.  
Bond Avenue, Denbigh East  
Milton Keynes, MK1 1SW  
United Kingdom



### FCC COMPLIANCE

This equipment has been tested and found to comply with the limits for a Class A digital device, pursuant to Part 15 of the FCC Rules. These limits are designed to provide reasonable protection against harmful interference when the equipment is operated in a commercial environment. The equipment generates, uses, and can radiate radio frequency energy and, if not installed and used in accordance with the instruction manual, may cause harmful interference to radio communications. Operation of this equipment in a residential area is likely to cause harmful interference in which case the user will be required to correct the interference at his own expense.

Shielded interconnect cables must be employed with this equipment to insure compliance with the pertinent RF emission limits governing this device.

Changes or modifications not expressly approved by Adam Equipment could void the user's authority to operate the equipment.

### WEEE COMPLIANCE

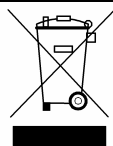

Sealed Lead Acid  
Battery  
Must be recycled  
Properly

Any Electrical or Electronic Equipment (EEE) component or assembly of parts intended to be incorporated into EEE devices as defined by European Directive 2002/95/EEC must be recycled or disposed using techniques that do not introduce hazardous substances harmful to our health or the environment as listed in Directive 2002/95/EC or amending legislation. Battery disposal in Landfill Sites is more regulated since July 2002 by regulation 9 of the Landfill (England and Wales) Regulations 2002 and Hazardous Waste Regulations 2005.

**ADAM EQUIPMENT** is an ISO 9001:2008 certified global company with more than 35 years experience in the production and sale of electronic weighing equipment.

For a complete listing of all Adam scales and balances visit our website at:

**[www.adamequipment.com](http://www.adamequipment.com)**

© Copyright by Adam Equipment Co. Ltd. All rights reserved. No part of this publication may be reprinted or translated in any form or by any means without the prior permission of Adam Equipment.

Adam Equipment reserves the right to make changes to the technology, features, specifications and design of the equipment without notice.

All information contained within this publication is to the best of our knowledge timely, complete and accurate when issued. However, we are not responsible for misinterpretations which may result from the reading of this material.

The latest version of this publication can be found on our Website.

Many aspects of design and internal operation of these scales are protected by Trade Mark and Patent Protection.

---

**Head Office:**

***Adam Equipment Co. Ltd.***

Bond Avenue,

Milton Keynes,

MK1 1 SW

United Kingdom

Tel: +44 (0)1908 274545

Fax: +44 (0)1908 641339

[sales@adamequipment.co.uk](mailto:sales@adamequipment.co.uk)

For regional office worldwide visit [www.adamequipment.com](http://www.adamequipment.com)