



Adam Equipment

AELP

PALLET BEAMS SCALES

(P.N. 4327, Rev. A6, June 2005)

Software revision: LAT 504

CONTENTS

1.0	INTRODUCTION	2
2.0	TECHNICAL SPECIFICATIONS	3
3.0	UNPACKING THE SCALE	4
4.0	SETTING UP THE SCALE	4
5.0	KEYPAD AND DISPLAY	5
5.1	KEY DESCRIPTION	5
5.2	DISPLAY SYMBOLS.....	6
6.0	FUNCTIONS.....	6
6.1	BL = AUTOMATIC BACKLIGHT CONTROL.....	7
6.2	AVE = DISPLAY AVERAGING RATE	8
6.3	FIL = ADC FILTER RATE	8
6.4	BOD = BAUD RATE SELECTION	8
6.5	CONT = CONTINUOUS PRINTING	9
6.6	PIECE = PARTS COUNTING.....	9
6.7	STEPS = CHECK-WEIGHING FUNCTION (LOW-OK-HIGH)	11
6.8	CALIBR = CALIBRATION ROUTINE	12
6.9	REPL = RESULTS PRINTED AUTOMATICALLY OR MANUALLY	12
6.10	StAb = PRINT WHEN STABLE OR INSTANTANEOUS	13
6.11	AUT = AUTOZERO FUNCTION	13
6.12	t1 = AUTOMATIC POWER SWITCH OFF	14
6.13	toP = HOLD MAXIMUM VALUE	14
6.14	nE = WEIGH IN NEWTONS	14
6.15	SuPP = POWER SUPPLY VOLTAGE TO PCB.....	15
7.0	COMMUNICATION WITH A COMPUTER/PRINTER.....	15
7.1	PARAMETER.....	15
7.2	CONNECTION.....	15
7.3	OUTPUT FORMAT	16
7.4	INPUT COMMANDS FORMAT	16

1.0 INTRODUCTION

AELP Pallet Beam Scales come with the following standard features:

- Lightweight for ease of handling
- Supplied complete with the AE 106 Indicator in plastic housing
- Precision load cells for accurate weighing results every time
- 5 weighing units for flexibility
- Handles for portability
- Low profile beams to allow easy weighing of pallets
- 2 beams per set
- Mains adapter supplied as standard

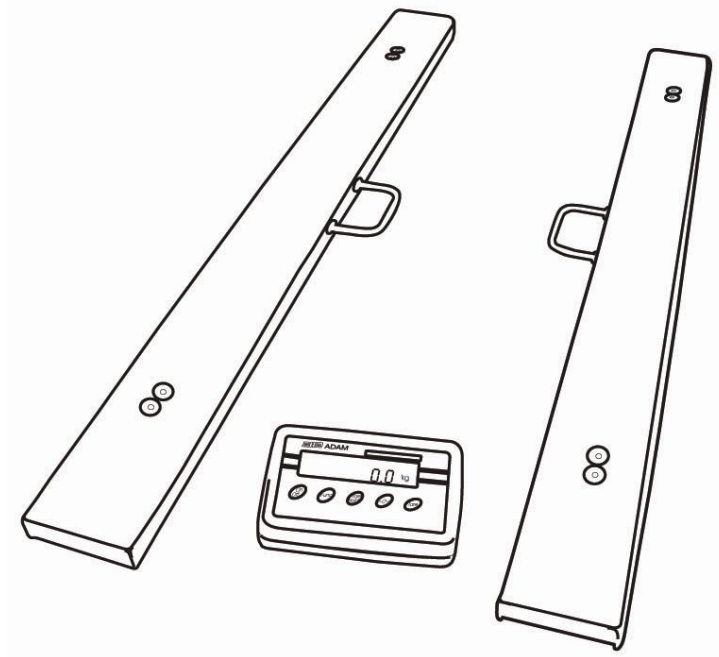

2.0 TECHNICAL SPECIFICATIONS

Models	AELP 500	AELP 2000
Maximum Capacity	500 kg	2000 kg
Readability	200 g	500 g
Resolution	200 g	500 g
Repeatability	200 g	500 g
Linearity (\pm)	200 g	1000 g
Internal counting resolution	Up to 60,000 divisions	
Tare range	Full	
Stabilisation time	Typically 3 seconds	
Units of measure	Kg, g, t or lb	
Interface	RS-232 bi-directional Interface	
Operating temperature	0 to 40 °C	
Power supply	10.5 VAC external adapter 6 x AA size Alkaline Dry-cell batteries are suggested	
Calibration	Push button calibration	
Display	16 mm LCD displays	
Pan size	1250 x 80 x 60 mm	
Net weight	28.3 kg	
Functions	Averaging level, baud rate, print when scale becomes stable or manually, print when stable or at any time, auto-zero disable, automatic power off, enable maximum value hold, enable weighing in Newtons	
Other features	Parts Counting and Check-weighing	

3.0 UNPACKING THE SCALE

- Remove the 2 sets of pallet beams using the handles provided.
- Take care while removing the beams to avoid banging or injury.
- Remove the Indicator and the power supply adapter packed separately.
- Place it on a levelled and firm floor.
- Position the beams side by side.

4.0 SETTING UP THE SCALE

- Plug in the Indicator into the socket provided at the back of the pallet beam (the one having two sockets).
- Ensure both the beams are connected via the beam-to-beam cable.
- Attach the Power Supply adapter to the Indicator and switch the main supply to ON.
- The Indicator can also be operated by using 6 x AA size batteries. (Alkaline batteries suggested).
- Read this User Manual before starting the weighing operation.
- Place the pallets on the beams for weighing.

5.0 KEYPAD AND DISPLAY

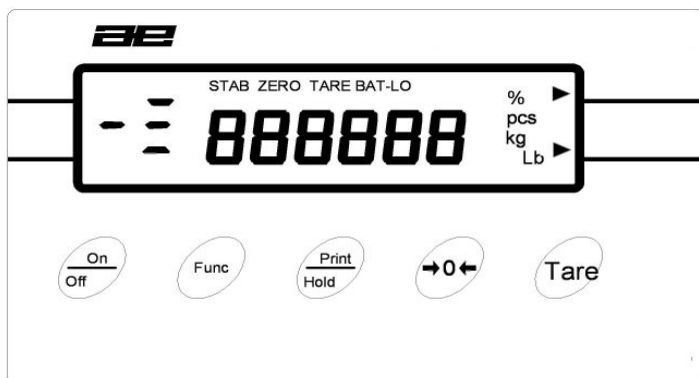

5.1 KEY DESCRIPTION



[On/Off]	Turns the scale on or off
[Print]	Initiates the RS-232 transmission
[Func]	Sets functions
[Zero]	Sets the display to zero with no weight on the platform.
[Tare]	Sets the display to zero by storing the current weight in the tare memory

- Turn the scale on using the **[On/Off]** key. After the display is zero, place an item to be weighed on the platform. The display will show the weight. The unit will be grams or kilograms as set by the supplier.
- To zero the display with no weight on the platform, press **[Zero]**.
- If a container is placed on the platform press **[Tare]** to zero the display. As material is added to the container only the weight of the material will be displayed. If necessary press **[Tare]** again to add more material if desired. Trying to tare a negative value will give the error “- **VAL**”.
- If the weight on the platform exceeds the permissible range of the **[Zero]** key ($\pm 4\%$ of capacity) the message “**VAL 4**” will be shown briefly. Either remove some weight or press **[Tare]** to zero the display.

5.2 DISPLAY SYMBOLS

Symbol	Description
ZERO	Scale in auto zero range (indication = accurate zero)
STAB	Result is stable
PCS	Scale in parts counting mode
kg or g or t	Scale in weighing mode
BAT-LO	Batteries are weak, after 5 minutes the scale will turn off
TARE	Scale has been tared
	When weight is above the High setpoint
	When weight is between the setpoints
	When weight is below the Low setpoint
- Lo -	During parts counting sample size is too small

6.0 FUNCTIONS

- To change functions press the **[Func]** key.
- The functions that are available can be cycled through by pressing **[Func]** key.
- Not all functions may be enabled. Some functions may be set during the initial configuration and the user is not given access to them. In this case those will not be seen when the **[Func]** key is pressed.
- To use any of the functions see the corresponding section of the manual.
- If you continue to press the **[Func]** key you will eventually be returned to weighing.

<i>Functions Available</i>		
	<i>Function</i>	<i>Description</i>
1.	bl	Enables / disables the backlight (if used)
2.	AVE	Changes averaging of weighing result
3.	bod	Changes baud rate for RS-232 transmission speed
4.	FIL	Changes ADC filtering
5.	cont	Enables or disables continuous printing
6.	PIECE*	Enters parts counting

7.	StEPS*	Enters check-weighing
8.	CALibr	Calibration routine
9.	rEPL	Sets RS-232 to transmit automatically or manually
10.	StAB	Sets the RS-232 to print only when stable or at any time
11.	Aut	Enables/disables the autozero function
12.	t1	Enables/disables the automatic turn off
13.	toP	Enables/disables the maximum hold feature
14.	nE	Changes to measuring in Newtons
15.	SuPP	Displays the power supply voltage

- Most functions only require a simple enable or disable (0 or 1) or a number that is incremented. Select the function using **[Func]**, then press **[Print]** to view the current setting. Pressing **[Print]** again will change the setting to the next value. Pressing **[Func]** again will return to normal weighing.
- On other functions (marked *) select the function by pressing **[Func]**. Press **[Print]** to enter the function menu. The program will then prompt you to enter values depending upon the function selected. It is necessary to use **[Tare]** to select a digit to change and press **[Print]** to increment the flashing digit. When all digits have been entered press **[Func]** to go to the next step.

6.1 **bl** = AUTOMATIC BACKLIGHT CONTROL

- If the scale includes a backlight, it can be either enabled or disabled.
- To set the parameter press the **[Func]** key to show "**bl**".
- Press **[Print]** to see the parameter.
- Press **[Print]** to select either "**bl= 0**" or "**bl= 1**".
"**bl= 0**" Backlight is enabled.
"**bl= 1**" Backlight is disabled.
- Press the **[Func]** key to return to weighing.

6.2 **AVE** = DISPLAY AVERAGING RATE

- It selects the required averaging for the display update.
- Press the **[Func]** key until **AVE** is displayed.
- Press **[Print]** to select the desired value.
- Press the **[Func]** key to return to weighing.
 - AVE 1** = Fastest display rate for uses such as filling.
 - AVE 5** = Slowest display rate for uses such as animal weighing or poor environment.
- Press the **[Func]** key to return to weighing.

6.3 **FIL** = ADC FILTER RATE

- It selects the required filter rate.
- Press the **[Func]** key until **FIL** is displayed.
- Press **[Print]** to select the desired value.
- Press the **[Func]** key to return to weighing.
 - FIL 1** = Fastest rate for speed.
 - FIL 4** = Slowest rate for poor environment.
- Press the **[Func]** key to return to weighing.

6.4 **bod** = BAUD RATE SELECTION

- It selects the required baud rate for the RS-232 communications.
- Press the **[Func]** key until "**bod**" is displayed.
- Press **[Print]** to select the desired value.
 - bod 1 = 300 Baud
 - bod 2 = 600 Baud
 - bod 3 = 1200 Baud
 - bod 4 = 2400 Baud
 - bod 5 = 4800 Baud (default)
 - bod 6 = 9600 Baud
- Press the **[Func]** key to return to weighing.

6.5 **cont** = CONTINUOUS PRINTING

This parameter is used to configure to print continuously whenever there is any weight on the balance or only when **[Print]** is pressed.

- To set the parameter press the **[Func]** key to show “**cont**”
- Press **[Print]** to see the parameter.
- Press **[Print]** to select either “**cont= 0**” or “**cont= 1**”.
 - “**cont= 0**” Continuous output is disabled. Prints only when the **[Print]** key is pressed.
 - “**cont= 1**” Continuous printing is enabled.
- Press the **[Func]** key to return to weighing.

6.6 **PIECE** = PARTS COUNTING

- Parts counting is used to display the number of items placed on the balance after a sample of the items is used to calibrate the balance.
- Place a container on the pan and press **[Tare]** to zero the display. Place a quantity of items to be counted in the container. The number of items is the sample size.
- To enter parts counting mode, press the **[Func]** key until “**PIECE**” is displayed.
- Press **[Print]** to enter parts counting mode. The sample size is displayed. To select a different sample size use the **[Tare]** key to select a digit and the **[Print]** key to increment the value. The sample size can be set in the range of 1 to 100,000.
- When the desired sample size is shown, press the **[Func]** key.
- The display will show “**LOAD**”. If the sample is not already on the pan, place it now.
- Press the **[Func]** key.
- The display will show the number of items in the sample. The display may show “**contr**” briefly while it is computing the number

of parts. If more items are added or removed from the balance, the display will show the new quantity.

Note that the display is limited to 6 digits, i.e. 999,999 pieces. If the quantity on the scale exceeds 999,999 the left most digits and any leading zeros will be lost, for example 1,002,305 will display as 2,305 pieces.

- When in use the balance can be tared normally to eliminate the package weight from the gross weight.
- To return to weighing, press the **[Func]** key to select "**PIECE**" and then press **[Tare]**.

Counting Accuracy

- The best accuracy is obtained with larger sample sizes. It is possible to use a smaller sample size to determine a larger sample accurately. This larger sample can then be used for counting a greater number of parts.
- If the items to be counted are not uniform, the results may be inaccurate.
- Care is needed not to exceed the capacity of the balance. The display will show "**FULL-2**" if the capacity is exceeded.

6.7 **StEPS** = CHECK-WEIGHING FUNCTION (LOW-OK-HIGH)

- The check-weighing function will show a symbol on the left side of the display to indicate if the current weight displayed is:
 - ▼ - above the **High setpoint**
 - ◄ - between the **setpoints**
 - ▲ - below the **Low setpoint**
- To enable the check-weighing function and set the value of the setpoints press the **[Func]** key until “**StEPS**” is displayed.
- Press **[Print]** to enter the function. The display will then show all zeros and the left most digit will be flashing. The LOW ▲ symbol will be on.
- Use the **[Tare]** key to set the digit to be changed and the **[Print]** key to set the value for the low setpoint. When the value is correct press **[Func]** to go to the high setpoint.
- Set the high setpoint and press **[Func]** to return to weighing.
- The display will indicate when the weight shown is below the low setpoint, between the setpoints or above the high setpoint.
- To disable the function press the **[Func]** key until either “**PIECE**” or “**StEPS**” is displayed and then press the **[Tare]** key.

6.8 **CALibr** = CALIBRATION ROUTINE

- To set the parameter press the **[Func]** key to show “**CALibr**”.
- Remove all weight from the platform.
- Press **[Print]** and the display will show “**noCAL**” while the scale is measuring the initial mass (pan must be empty).
- Then the display will show “**LOAD xxx**” where **xxx** is the required calibration weight.
- Place the weight on the platform then press **[Print]** – display will show “**CAL**” and then (after calibration) “**unLoAd**”.
- Remove the calibration weight – the scale will return to normal weighing.

6.9 **rePL** = RESULTS PRINTED AUTOMATICALLY OR MANUALLY

- This parameter controls the operation of the RS-232 interface.
- The balance can be configured to either print automatically when the balance becomes stable or only when **[Print]** is pressed.
- To set the parameter press the **[Func]** key to show “**rePL**”.
- Press **[Print]** to see the parameter.
- Press **[Print]** to select either “**rePL= 0**” or “**rePL= 1**”.
“**rePL= 0**” Manual output when **[Print]** key is pressed.
“**rePL= 1**” Automatically print when the results are stable.
- Press the **[Func]** key to return to weighing.

6.10 **StAb** = PRINT WHEN STABLE or INSTANTANEOUS

- When the scale is set to manual print (**rePL = 0**), the balance can be set to print either immediately after the **[Print]** key is pressed or only after the balance is stable. The function can also be enabled from the RS-232 interface. See Section 3: Communication with a Computer or Printer.
- To set the parameter press the **[Func]** key to show "**StAb**".
- Press the **[Print]** key to see the parameter. Press **[Print]** to select either "**StAb= 0**" or "**StAb= 1**".

"**StAb= 0**" Sends weight results only when the balance is stable.

"**StAb= 1**" Sends the results immediately after **[Print]** is pressed.

NOTE: If "**StAb= 0**" then "**rePL**" should be set to "**rePL= 0**" also.

- Press the **[Func]** key to return to weighing.

6.11 **Aut** = AUTOZERO FUNCTION

The scale has an autozero function to automatically rezero the balance. This function will reset the zero if it should drift from the initial zero condition. The autozero function is normally enabled to ensure a stable zero condition. However some operations may be affected by the autozero function. Examples are filling applications where the material flows very slowly and evaporation, if the user tares the balance with the sample on the pan and is looking for the amount of material that might evaporate. In these conditions, the autozero may be disabled.

- To set the parameter press the **[Func]** key to show ZERO.
- Press **[Print]** to see the parameter.
- Press **[Print]** to select either "**Aut = 0**" or "**Aut = 1**".

"**Aut = 0**" Autozero function is enabled.

"**Aut = 1**" Autozero function is disabled.

- Press the **[Func]** key to return to weighing.

6.12 **t1** = AUTOMATIC POWER SWITCH OFF

The scale includes an internal battery. The typical operation time using only the battery is 50 hours if one load cell is used and about 12 hours if four are used. The scale includes the “**t1**” function to turn the power off after 5 minutes if it is not being used. This function can be disabled if the balance is powered from the main power supply or if the disruption of power affect the weighing procedure.

- To set the parameter press the [**Func**] key to show “**t1**”
- Press [**Print**] to see the parameter. Press [**Print**] to select either “**t1=0**” or “**t1=1**”.
 - “**t1=0**” Automatic switch off is enabled.
 - “**t1=1**” Automatic switch off is disabled.
- Press the [**Func**] key to return to weighing.

6.13 **toP** = HOLD MAXIMUM VALUE

The display will hold the maximum value weight placed on the pan until the balance is tared. When a weight is placed on the pan the display will hold the highest reading until the operator presses [**Zero**] to reset the display to zero. When the function is enabled it will show a symbol  at the second digit.

- To set the parameter press the [**Func**] key to show “**toP**”.
- Press [**Print**] to see the current parameter.
- Press [**Print**] to select either “**toP=0**” or “**toP=1**”.
 - “**toP=0**” Hold function is disabled.
 - “**toP=1**” Hold function is enabled.
- Press the [**Func**] key to return to weighing.

6.14 **nE** = WEIGH IN NEWTONS

The balance can display the unknown weight in Newtons. When Newtons are selected the weight legend on the display will be turned off and a dash symbol  will be turned on underneath the 2nd digit from the left.

- To set the parameter press the [**Func**] key to show “**nE**”.
- Press [**Print**] to see the current parameter.
- Press [**Print**] to select either “**nE=0**” or “**nE=1**”.
 - “**nE=0**” Weigh in kilograms.
 - “**nE=1**” Weigh in Newtons.
- Press the [**Func**] key to return to weighing.

6.15 **SuPP** = Power supply voltage to PCB

- To set the parameter press the **[Func]** key to show “**SuPP**”.
- Press **[Print]** to see the parameter.
- The display will show the current voltage to the PCB.
- Press any key to return to normal weighing.

7.0 COMMUNICATION WITH A COMPUTER/PRINTER

The following applies only to scales supplied with an RS-232 interface.

- Press the **[Print]** key to transmit weighing data (value and unit of mass) to a computer or printer.
- The AE 106 indicator can be connected to a printer for printing the results of the weighing or to a computer to either display or control the balance through the RS-232 interface. The commands can tare the balance or request the weight be printed.

7.1 PARAMETER

The interface parameters are:

300 - 9600 Baud as selected, see section 2.3, default 4800 baud
8 data bit
No parity
1 stop bit

7.2 CONNECTION

Depending upon case style the output is either using a 9 pin D-subminiature connector or a 6 pin Audio Connector.

If the output connector is a 9 pin D-subminiature plug. The output pins are:

Pin 2 Input
Pin 3 Output
Pin 5 Signal Ground

It is necessary to jumper pin 7 to pin 8 to enable the RS-232 interface circuits. Do not connect these pins to the handshaking pins on the interfaced device.

If the output connector is a 6 pin audio connector. The output pins are:

Pin 2	Input
Pin 3	Output
Pin 5	Signal Ground

It is necessary to jumper pin 1 to pin 6 to enable the RS-232 interface circuits. Do not connect these pins to the handshaking pins on the interfaced device.

7.3 OUTPUT FORMAT

The balance will output the weight with the units of measure on one line. The output is initiated when the **[Print]** key is pressed or a command is received over the RS-232 interface.

\pm w w w • w w w _ _ u u u <cr><lf>
Sign, weight unit of weight

Units of weight used are:

kg= kilogram, t= tonne, g= gram, lb= Pounds, pcs= parts.

7.4 INPUT COMMANDS FORMAT

The balance can be controlled with the following commands. The commands must be sent in upper case letters, i.e. "T" not "t". The balance will send the message "ES" if it does not understand a command that is sent to it.

T<cr><lf>	The uppercase T will tare the balance. This is the same as pressing [Tare] .
Z<cr><lf>	The uppercase Z will zero the balance. This is the same as pressing [Zero] .
SI<cr><lf>	The SI command will cause the weight to be transmitted over the RS-232 interface. This is the same as pressing the [Print] key.
S0<cr><lf>	The S0 (S-zero not S "oh") command will cause the weight to be transmitted over the RS-232 interface automatically when the results are stable. This is same as setting the parameter " rEPL = 1 ".
S1<cr><lf>	The S1 command will cause the weight to be transmitted over the RS-232 interface manually by pressing [Print] or by sending the SI command.



Manufacturer's Declaration of Conformity

This product has been manufactured in accordance with the harmonised European standards, following the provisions of the below stated directives:

Electro Magnetic Compatibility Directive 89/336/EEC

Low Voltage Directive 73/23/EEC

Adam Equipment Co. Ltd.
Bond Avenue
Denbigh East Estate
Milton Keynes, MK1 1SW
United Kingdom

FCC COMPLIANCE

This equipment has been tested and found to comply with the limits for a Class A digital device, pursuant to Part 15 of the FCC Rules. These limits are designed to provide reasonable protection against harmful interference when the equipment is operated in a commercial environment. The equipment generates, uses, and can radiate radio frequency energy and, if not installed and used in accordance with the instruction manual, may cause harmful interference to radio communications. Operation of this equipment in a residential area is likely to cause harmful interference in which case the user will be required to correct the interference at his own expense.

Shielded interconnect cables must be employed with this equipment to insure compliance with the pertinent RF emission limits governing this device.

Changes or modifications not expressly approved by Adam Equipment could void the user's authority to operate the equipment.

ADAM EQUIPMENT is an ISO 9001:2000 certified global organisation with more than 30 years experience in the production and sale of electronic weighing equipments. Products are sold through a world wide distributor network -supported from our company locations in the UK, USA and SOUTH AFRICA. The company and their distributors offer a full range of Technical Services such as on site and workshop repair, preventative maintenance and calibration facilities.

ADAM's products are predominantly designed for the Laboratory, Educational, Medical and Industrial Segments. The product range can be classified as follows:

- Analytical and Precision Laboratory Balances
- Top Loading Scales for Educational establishments
- Counting Scales for Industrial and Warehouse applications
- Digital Weighing/Check-weighing Scales
- High performance Platform Scales with extensive software features including parts counting, percent weighing etc.
- Digital Electronic Scales for Medical use
- Retail Scales for price computing

<p>Adam Equipment Co. Ltd. Bond Avenue Milton Keynes MK1 1SW UK</p> <p>Phone: +44 (0)1908 274545 Fax: +44 (0)1908 641339</p> <p>e-mail: sales@adamequipment.co.uk</p>	<p>Adam Equipment Inc. 26, Commerce Drive Danbury, CT 06810 USA</p> <p>Phone: +1 203 790 4774 Fax: +1 203 792 3406</p> <p>e-mail: sales@adamequipment.com</p>	<p>Adam Equipment S.A. (Pty) Ltd. P.O. Box 1422 Kempton Park 1620 Johannesburg Republic of South Africa</p> <p>Phone +27 (0)11 974 9745 Fax: +27 (0)11 392 2587</p> <p>e-mail: sales@adamequipment.co.za</p>
---	---	--

© Copyright by Adam Equipment Co. Ltd. All rights reserved. No part of this publication may be reprinted or translated in any form or by any means without the prior permission of Adam Equipment.

Adam Equipment reserves the right to make changes to the technology, features, specifications and design of the equipment without notice.

All information contained within this publication was to the best of our knowledge timely, complete and accurate when issued. However, we are not responsible for misimpressions which may result from the reading of this material.

The latest version of this publication can be found on our Website.

Visit us at www.adamequipment.com